



The ASG Nav-P 4.0 System User Manual



Table of Contents

Section 1: Preliminary Information.....	5
1.1 Safety Symbols and Signals Used in the Manual.....	5
1.2 Document Identification.....	5
1.3 Manual Ownership.....	5
1.4 Validity	6
1.5 Importance of this Manual.....	6
1.6 Manual Storage and Retention	6
1.7 Manual Preservation	6
1.8 Supplier Identification	7
1.9 Service and Support	7
1.10 Pictograms	7
1.11 Device Identification	9
1.11.1 Device Name.....	9
1.12 Device Incoming Inspection	9
1.13 Customer Responsibility Provisions.....	9
1.14 Warranty	9
Section 2: Warnings.....	10
2.1 Risk Prevention	10
2.2 Responsibility.....	10
2.3 Expected Use	10
2.4 Use Limits	10
2.5 Good Usage Rules.....	11
2.6 Forbidden Actions	11
2.7 Installment Warnings	11
2.8 Adjustment and Startup Warnings.....	11
2.9 Maintenance and Cleaning Warnings.....	11
2.10 Indications for Dismantling and Disposal.....	11
2.11 Lighting Warnings	12



Table of Contents (Continued)

Section 3: Product Specifications	12
3.1 General Information.....	12
3.2 Hardware	12
3.3 Technical Features	14
3.3.1 Connection Specification.....	14
3.3.2 Connector Layout.....	15
3.4 Input/Output Description	16
Section 4: Installation.....	18
4.1 Warnings	18
4.1.1 General Warnings.....	18
4.2 Installation	18
4.2.1 Installation Options.....	19
4.2.2 Screen Inclination.....	19
4.3 Connection Scheme - Example.....	20
Section 5: Operating Instructions	21
5.1 Introduction	21
5.1.1 HMI Interface	21
5.1.2 Language Selection.....	21
5.1.3 Access Mode	22
Section 6: Programming.....	23
6.1 Main Screen Descriptions.....	23
6.2 Access to Administrator Mode	23
6.3 Exit Administrator Mode	26
6.4 Setting the Reference Start Position.....	26
6.4.1 Daily Confirmation or Restoration of Reference Unit	27
6.5 Setup of Default Positioning Tolerances	27
6.6 Upload Part Pictures or Images to Device	28
6.7 Positioning Tag Design	31
6.7.1 Tag Design Sequence	32
6.7.2 Management of Multiple Pictures.....	35
6.8 Teaching the Tightening Sequence Positions	35
6.8.1 Tag Modification	39



Table of Contents (Continued)



Section 7: Setup of Additional Functions.....	40
7.1 Clamper	40
7.2 Run Mode	40
7.3 On Failed Operation	41
7.4 Max Operation Retry.....	41
7.5 Activation Back Key.....	42
7.6 Tool Enabled When Output Is	42
7.7 Barcode Reader Setup.....	43
7.8 Teach Tray.....	45
7.8.1 Tray Number Assignment to Work Circle	46
7.9 Out of Position (OOP) Reference	47
Section 8: Work Mode	50
8.1 Work Cycle	50
8.1.1 Work Cycle with OOP Function Active	51
8.2 Positioning Sequence Simulation	51
8.3 Job Selection From External Source.....	52
Section 9: Maintenance.....	53
Section 10: Disposal	53
Section 11: Limited Warranty	53
Section 12: Appendixes	54
12.1 ASG Nav-P 4.0 Power Unit	54
12.2 Barcode Reader.....	56
12.3 Digital Inputs	58
12.4 Digital Outputs.....	59



Section 1: Preliminary Information

1.1 Safety Symbols and Signals Used in the Manual

- Attach a proper adapter to connect the driver to the 3/8" female square.
- **NOTE:** It is NOT recommended to use the power tool adapters to calibrate hand torque tools.
- Select **FIRST PEAK** mode using the **MODE** button. Press the **RESET/ESC** button if the display is not at 0.
- Turn the driver or wrench clockwise or counterclockwise until the "break" point is reached.
- In **FIRST PEAK** no other reading can then be displayed until the reset button is pressed.
- The LCD display will show the torque that the driver or wrench is set at. Note the reading or write it down. To enter it into the DTT memory, press the **MEM/ENTER** button. If you are testing several tools note the memory numbers of the readings for the various tools. This number is in the upper right hand corner of the LCD. The unit can save up to 500 readings. After that no further readings can be entered until the memory is cleared. See the main menu section starting on page 11 for instructions on downloading and clearing the readings in the memory.
- If the torque is not correct, adjust the tool. Repeat the test. When the reading is proper, perform the test several times to be sure the readings are consistent. The proper reading may be an average of several readings.

	Care Point
	Warning Sign. Maximum care required.
	Individual Protection is Mandatory, i.e. protective gloves

1.2 Document Identification

Date of First Publication: December 2016

Revision Number: Rev. A

Date of Last Revision: 12/14/16

1.3 Manual Ownership

- The property rights of this manual belong exclusively to ASG, Division of Jergens, Inc.. This right is conceded to the buyer in terms of use of this manual exclusively for personal use.
- Translations, printing and other copying of this manual, even if partial and/or in any other form, must be accompanied by the expressed consent of ASG, Division of Jergens, Inc.

ASG, Division of Jergens, Inc.

15700 S. Waterloo Road | Cleveland, OH 44110-3898 | Phone: (888) 486-6163 | Fax: (216) 481-4519 | Email: asginfo@asg-jergens.com | Web: www.asg-jergens.com



Section 1: Preliminary Information (Continued)

1.4 Validity

- This manual is referred to the device ASG Nav-P 4.0 and reflects the features contained at the time this manual was written.
- The builder reserves the right to make changes to the present manual without advance notice.
- Changes to the present manual decided by the manufacturer might be sent to users. In this case the user will be responsible.

1.5 Importance of this Manual

- Among the information included in this manual, items related to safety devices and safe operation modes to avoid damage to equipment or injury to humans have to be considered as very important.



- Prior to use, is mandatory to read this manual with maximum care. The proper function and the lifespan of the machinery depends on the observance and fulfillment of procedures described in the manual.

1.6 Manual Storage and Retention

- Safety and Prevention Manager
- Equipment installation personnel
- Training and maintenance personnel
- Device operators
- Eventual disposal personnel

1.7 Manual Preservation

- The manual must be preserved in good condition and kept in appropriate location, known to all users and always available for the reference
- The builder must be contacted in case the manual is lost, damaged or to request additional copies
- The manual should be kept until device demolition
- Should the device be sold to another user, this manual and related CE declaration are to be delivered to the new owner



Section 1: Preliminary Information (Continued)

1.8 Supplier Identification

Supplier:	ASG, Division of Jergens, Inc.
Location:	15700 S. Waterloo Road Cleveland, OH 44110 USA
Phone:	888-486-6163
Fax:	216-481-4519
E-Mail:	asginfo@asg-jergens.com
Service Support:	asginfo@asg-jergens.com

1.9 Service and Support





- For any need related to use, maintenance, and spare parts; please contact ASG or an authorized distributor directly. Please be prepared to specify the identification data mentioned on the CE label applied on the device.
 - We strongly recommend to avoid any repair or modification which is not mentioned in this manual.
 - All specialized operations requiring more complicated repairs must be done exclusively by ASG authorized personnel.
- !**
- Any unauthorized modification will immediately invalidate the warranty.
 - Please have information printed on the device identification CE label (Serial, Year) available if requesting assistance or spare parts.

1.10 Pictograms

- Pictograms have been applied in areas easily visible for anyone who is approaching the device in order to prevent potentially dangerous situations.
- When possible, pictograms should be placed in areas not exposed to possible damage, wear, chemicals, dust or any other agent which may reduce the visibility and readability.
- Temperature use range should be between -40°F and 176°F (-40°C and +80°C).
- Surfaces must be appropriately clean, smooth and free from oils, grease or chemicals prior to pictograms application.
- Regulations require that safety pictographs have to be regularly checked and cleaned to ensure their readability from a safe distance.
- Should the pictograms be submitted to extreme environmental conditions or lose the required visibility features, they must be replaced.

Section 1: Preliminary Information (Continued)

1.10 Pictograms (Continued)

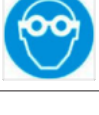
ID.	Symbol	Description
Pictograms Related to Hazards		
3		Generic hazard Read instructions carefully
Pictograms Related to Prohibitions		
4		Use forbidden by unauthorized personnel
Pictograms Related to Obligations		
		Protective gloves must be worn
		Safety shoes must be worn
		Protective clothing must be worn
		Protective goggles must be worn



Section 1: Preliminary Information (Continued)

1.11 Device Identification

1.11.1 Device Name

- The manufactured object of this manual is named the ASG Nav-P 4.0 system and is intended only for industrial use.

1.12 Device Incoming Inspection

- Check that the goods correspond to the shipping document contents. Should some components be missing, inform ASG immediately.
- Check for damage on the packaging due to transportation. Should relevant damage be found, inform the courier and note the damage on the shipping documents.
- Claims for damages relevant to transportation must be sent in accordance with the policies of the respective transportation courier.

1.13 Customer Responsibility Provisions

- Unless specific contractual agreements state otherwise, the customer is responsible for:
 - Installation area preparation, including utility installation, if required.
 - Electrical power, in conformity with any local laws in force

1.14 Warranty

- The device is covered under warranty from manufacturing defects. Warranty details are mentioned in Section 11.



Section 2: Warnings

2.1 Risk Prevention

- Personnel operating the device must be professionally trained and able to read and understand the instructions of this manual.
- Before, during, and after device set up, the user is recommended to use personal protective equipment (PPE) according to current regulations, such as:
 - Protective gloves for manipulation of parts with irregular surface or sharp edges;
 - Crush resistant shoes for manufacturing of heavy parts;
 - Safety earmuff when the work environment requires them;
 - Protective goggles to protect against powder, splinters, etc.
 - Lung protection systems if the environment requires them.

2.2 Responsibility

- ASG, Division of Jergens, Inc. denies any responsibility for consequences of:
 - Use of the device in violation of general safety protection regulations and by local laws in which the device is used;
 - Improper predisposition of structures on which the device will be installed;
 - Feeding of device electrical circuits with different voltage than those prescribed;
 - Failure to comply with instructions mentioned in the manual;
 - Exceptional events, calamities

2.3 Expected Use

- The device must be used only in the following conditions:
 - For professional use, by properly trained personnel
 - For purposes indicated in "Technical Features" section

2.4 Use Limits

- The device must not be used in the following conditions:
 - In areas with risk of fire and explosion, aggressive environments or with high concentration of sprayed oils, exposed to weather
 - By two or more people, as indicated in this manual;
 - In case damages found either on the structure or components of the device ;
 - For different uses than those for which the device has been designed;

ASG, Division of Jergens, Inc.



| Section 2: Warnings (Continued)

2.5 Good Usage Rules

- Learn how to stop the device in case of emergency
- Learn how to use all commands and functions
- Comply with all warning and hazard indications applied to the device
- Always use Personal Protective Equipment
- Personnel in training must be always be supervised by expert personnel
- Promptly inform ASG in case of defects, malfunction of safety devices and for any other potential danger situations

2.6 Forbidden Actions

- Do not modify the device or devices included in the assembly for any reason. ASG denies any responsibility for malfunctions caused by unauthorized modifications and/or alterations of the device.
- Do not operate outside from one's own competence

2.7 Installation Warnings

- See "Installation" section

2.8 Adjustment and Startup Warnings

- See "Functions and Adjustments" section

2.9 Maintenance and Cleaning Warnings

- See "Maintenance" section

2.10 Indications for Dismantling and Disposal

- See "Installation" section



| Section 2: Warnings (Continued)

2.11 Lighting Warnings

- Customer is responsible for appropriate lighting of the area in which the device will be installed, ensuring that:
 - Visibility inside the work environment is in conformity with local safety codes, to avoid dangerous conditions, and to ensure clear readability of commands installed on the device

| Section 3: Product Specifications

3.1 Lighting Warnings

- The ASG Nav-P 4.0 is designed in order to help the operator during screw tightening operations which are normally performed during industrial assembly processes
- It allows control of the tool position in order to perform screw tightening according to a pre-defined work sequence
- The device is supplied with electrical power only

3.2 Hardware

- Management up to 4 axis encoders
- 1 USB port HOST 2.0;
- Power supply 24Vdc;
- Dimensions (without frame): 121 x 195 x 61 mm (W x H x D);
- Display version:
 - LCD TFT 7" Wide 262000 colors, resolution 800x480 touch-screen;
 - Dimensions 208 x 179 x 135 x 5 mm (W x H x D)

Section 3: Product Specifications(Continued)

3.2 Hardware (Continued)

- Overall Dimensions in mm

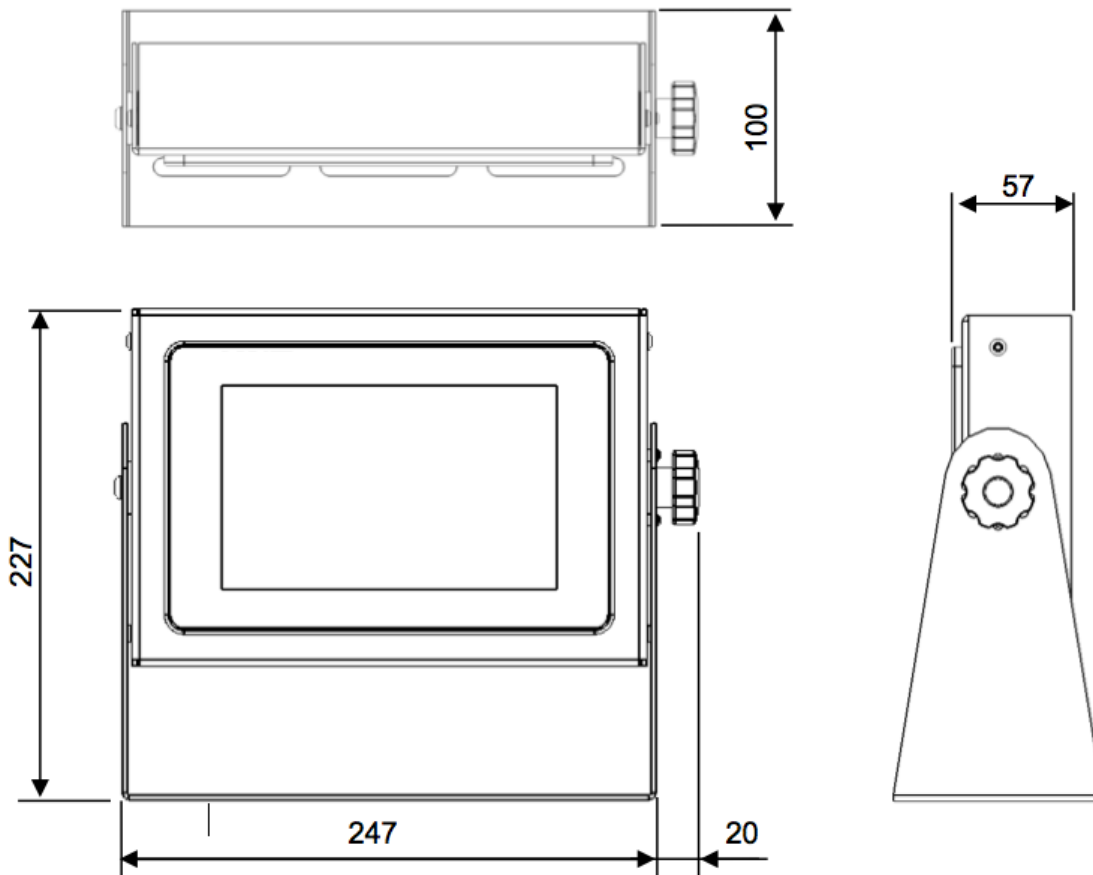



Section 3: Product Specifications(Continued)

3.3 Technical Features

3.3.1 Connection Specification

General Installation Specifications

General Notes:

- The installation staff must be suitably qualified and competent and must read the manual before beginning the installation
- Installers should follow this manual for correct installation. Clarify any questions with ASG prior to beginning installation
- ASG accepts no liability for any damage resulting from incorrect installation or inappropriate use of the ASG Nav-P 4.0

Installation Notes:

- When installing the controller, conform to all local electrical codes and the safety standards in force.
 - **!** In particular, ensure that any emergency stop circuits used must be constituted with electro mechanical components and must not be dependent on hardware or software.
- To prevent problems due to interference between power and control signals, follow these suggestions:
 - Power and control cables must be separated (min. 20 cm) and, if crossing is necessary, they should cross at a 90° angle
 - If possible, the power area (driver controllers, etc) and the control area (ASG Nav-P 4.0), must be physically separated with an interruption of any metal base
 - Use adequate noise suppressor (filters, and so on)

Danger of Damage Due To Improper Connection

- The electronic components of the ASG Nav-P 4.0 are equipped with many protection circuits. However, the following rules must be accurately adhered to:
 - Connect the inputs (digital and analog) of controls only at voltages corresponding to those indicated in technical characteristics
 - The load on outputs (digital and analog) must correspond to technical characteristics indicated, and in particular the outputs are not protected against short circuit
- **!** In advance of high voltage testing (insulation resistance test) the device must be disconnected to prevent damage to electronic components

Section 3: Product Specifications(Continued)

3.3 Technical Features

3.3.2 Connector Layout

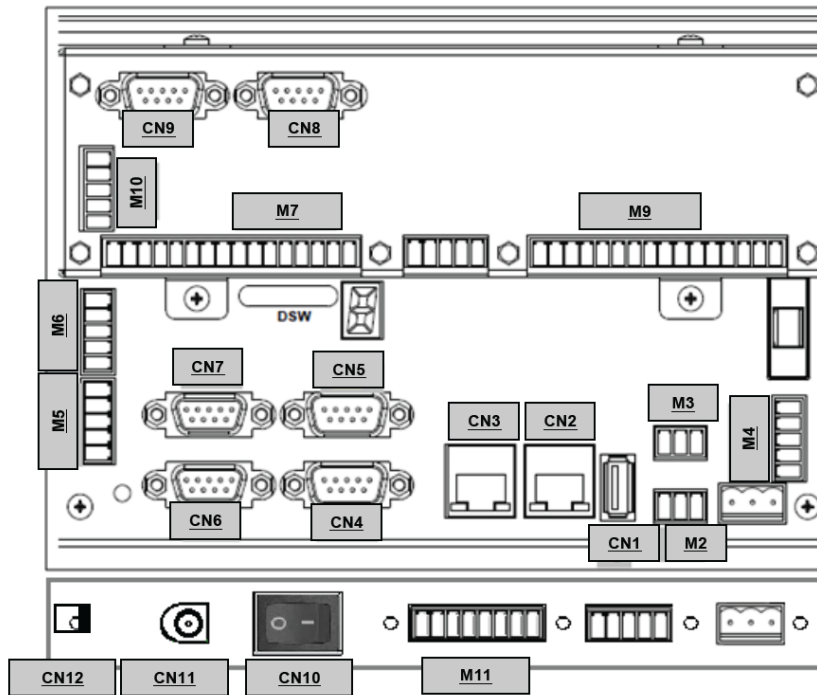

Connector	Function	Connector	Function
CN1	USB port	M2	CAN OPEN 1 (NOT USED)
CN2	ETHERNET network (NOT USED)	M3	CAN OPEN 2 (NOT USED)
CN3	ETHERCAT network (NOT USED)	M4	INTERRUPT INPUT
CN4	Encoder 1	M5	ANALOG OUTPUT (NOT USED)
CN5	Encoder 2	M6	ANALOG INPUT (NOT USED)
CN6	COM1-COM2 : RS232	M7	DIGITAL INPUT
CN7	COM3: RS232/RS242/RS485	M9	DIGITAL OUTPUT
CN8	Encoder 4	M10	ANALOG OUTPUT (NOT USED)
CN9	Encoder 3	M11	POWERED COMMON I/O FOR USER APPLICATIONS (4 x 0 VDC + 4 x 24 VDC)
CN10	ON/OFF SWITCH		
CN11	POWER SUPPLY		
CN12	GROUND CONNECTION		



Section 3: Product Specifications(Continued)

3.4 Input/Output Description

Input/Output Charts

INPUT 24 Vdc [M7]			
PIN	Name	Description	Required
1	OK Tool 1	Tightening OK signal from tool controller	x
2	NOK Tool 1	Tightening NOK signal from tool controller	x
3	Clamp Closed	Block signal activated (sensor)	
4	External Start	Start sequence from external input	
5	External Reset	Reset sequence from external input	
6	External Back	Repeat tightening signal from external input (even if screw was correctly tightened)	
7	External NOK Acknowledge	Accept a NOK result through digital input	
8	Loosening/Rework	Activate un-tightening from external input	
9	Force External Job Selection	Activate external sequence selection. When this input is active the work sequence will be selected by selection input only. Other selection methods will be disregarded	
10	Job Select Bit 1	Value of Bit 1 external sequence selection (0-5 bits available)	
11	Job Select Bit 2	Value of Bit 2 external sequence selection (0-5 bits available)	
12	Job Select Bit 4	Value of Bit 4 external sequence selection (0-5 bits available)	
13	Job Select Bit 8	Value of Bit 8 external sequence selection (0-5 bits available)	
14	Job Select Bit 16	Value of Bit 16 external sequence selection (0-5 bits available)	
15	Job Select Bit 32	Value of Bit 32 external sequence selection (0-5 bits available)	



Section 3: Product Specifications(Continued)

3.4 Input/Output Description (Continued)

Input/Output Charts

OUTPUT 24 Vdc [M9]			
PIN	Name	Description	Required
1	Output Ready	Positioning system ready to start	
2	Output in Job	Active when job is being performed	
3	Out Clamp 1	Activate component blocking electro-valve 2 possible modes: <ul style="list-style-type: none"> Out clamp 1 activated: to command mono-stable valve (continuous power feed of locking reel) Out clamp 1 and Out clamp 2 activated: to command dual-stable valve (gives pulse to power locking reel) 	
4	Out Clamp 2	Deactivation of component blocking electro-valve <ul style="list-style-type: none"> Out clamp 1 and Out clamp 2 activated: to command dual-stable valve (gives pulse to power locking reel) 	
5	Out Tool 1 Enable	Power tool enabled	x
6	Out in Position	Active when tightening position is correct	
7	Out OK	Active when single tightening got OK result in the pre-defined pos	
8	Out NOK	Active when tightening position is incorrect	
9	Out Complete OK	Active when all tightenings received OK result in the pre-defined positions	
10	Out Complete NOK	Active when one or more tightening(s) received a NOK result or when job has been cancelled.	
11	Out Cycle Bit-1	Cycle Bit 1 cycle selection (0-5 bit possible)	*
12	Out Cycle Bit-2	Cycle Bit 2 cycle selection (0-5 bit possible)	*
13	Out Cycle Bit-4	Cycle Bit 4 cycle selection (0-5 bit possible)	
14	Out Cycle Bit-8	Cycle Bit 8 cycle selection (0-5 bit possible)	
15	Out Cycle Bit-16	Cycle Bit 16 cycle selection (0-5 bit possible)	
16	Out Cycle Bit-32	Cycle Bit 32 cycle selection (0-5 bit possible)	

Section 4: Installation

4.1 Warnings

4.1.1 General Warnings



- All operations must be carried out by qualified & authorized personnel.
- Operators must wear personal protective equipment appropriate to the kind of operations performed.
- Failure to comply with following paragraphs, will relieve ASG, Division of Jergens, Inc. of any responsibility in case of accident, damage, or malfunctions of the device .

4.2 Installation

4.2.1 Installation Options

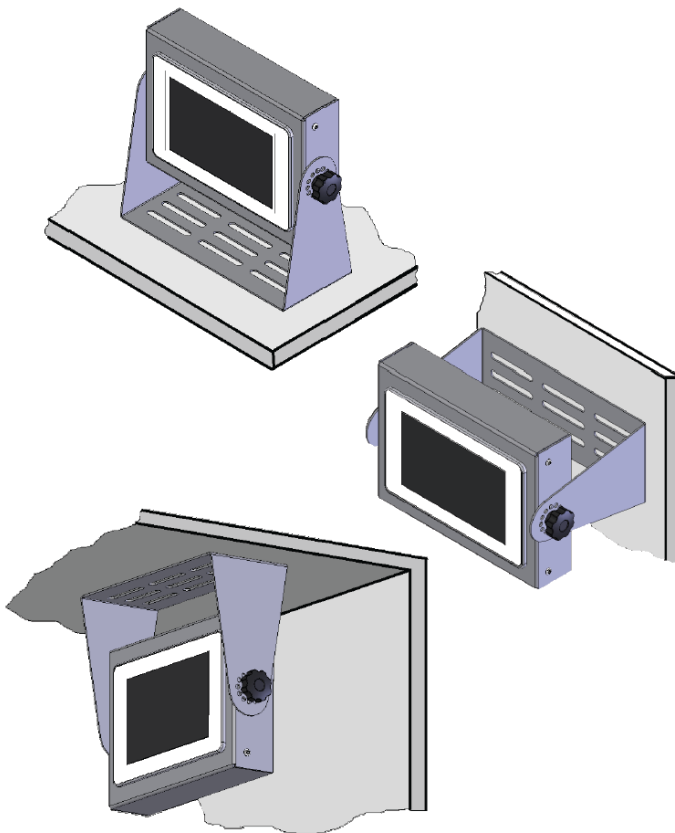

Section 4: Installation (Continued)

4.2 Installation (Continued)

4.2.2 Screen Inclination

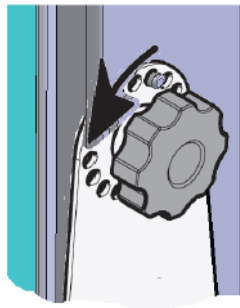

1

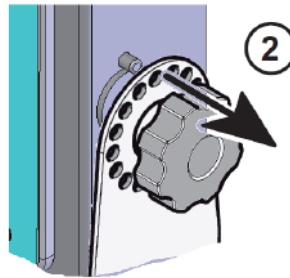

2

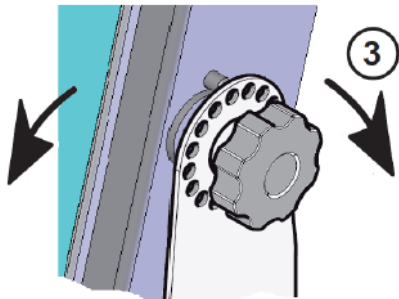

3

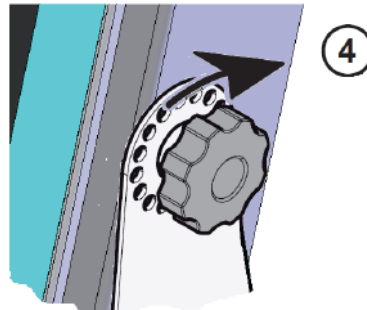

4

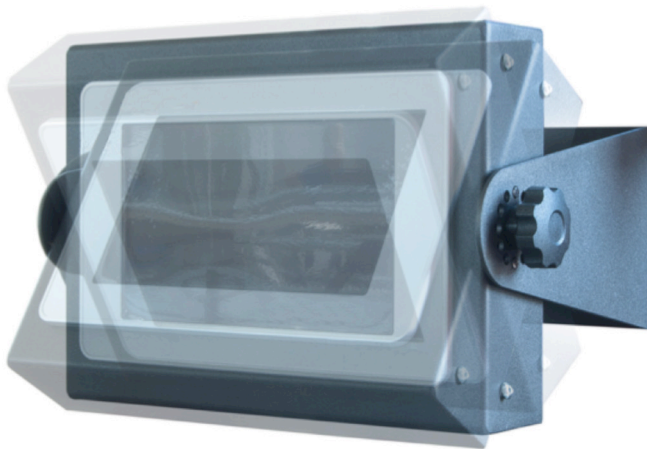

Section 4: Installation (Continued)

4.3 Connection Scheme - Example

Tool Controller



Controller Connection

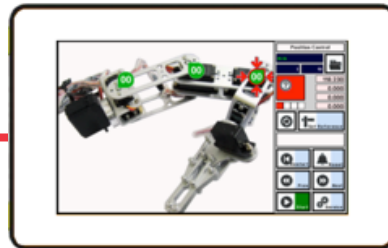

Encoder Connection

Tool Connection

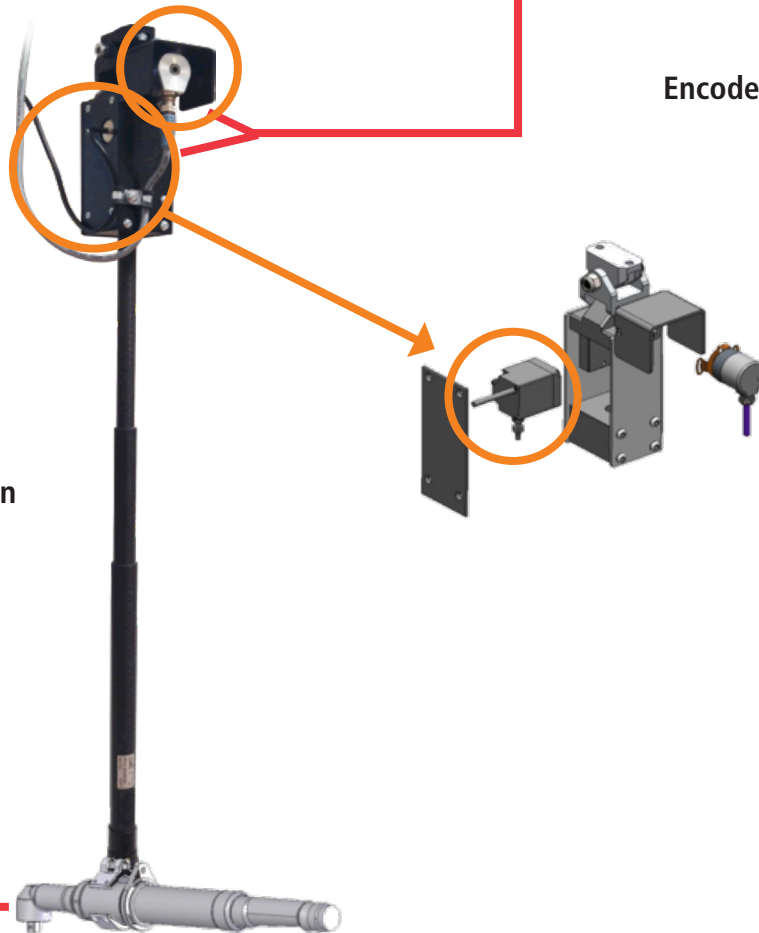

Section 5: Operating Instructions

5.1 Introduction

- ! Do not alter or disconnect the device during use.
- Failure to observe warnings in this manual or unauthorized alteration, will relieve ASG, Division of Jergens, Inc. from any responsibility of damage and/or injuries to people or property that may occur.

5.1.1 HMI Interface

To access all ASG Nav-P 4.0 functions, users will use the touch-screen HMI. The appearance of the main screen is shown below:

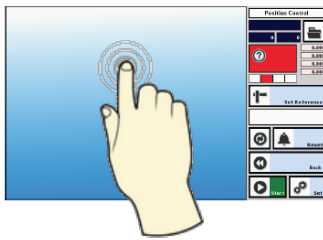

5.1.2 Language Selection

Currently available languages: Italian, English

To select appropriate language, tap "Set" ("Imp." if currently set to Italian) from main screen

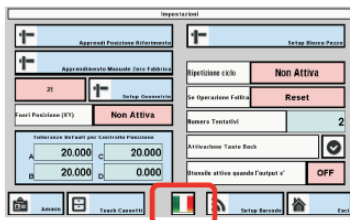
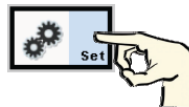
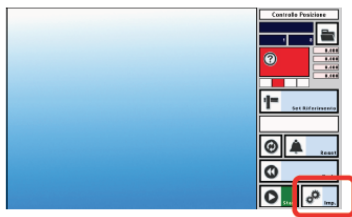

Tap "Back" and return to main screen. Now the language is set to English.



Section 5: Operating Instructions

5.1 Introduction (Continued)

5.1.3 Access Mode

ASG Nav-P 4.0 software allows two levels of access, with different functionality:

- Administrator mode: hereinafter called Admin
- User mode: hereinafter called User

Admin mode functionality:

- Programming
 - Positioning reference setup
 - Picture upload
 - Position teaching
 - Activation/deactivation of additional functions
 - Modification of factory settings (under ASG supervision only)

User mode functionality:

- Operator Functions
 - Position reference confirmation
 - Process with positioning functions
 - Production program selections

Admin functions are accessible through a password supplied by ASG with the device.



- The Administrator password is fixed and cannot be modified. The end-user is responsible for appropriate use, distribution, and storage of the password.

Section 6: Programming

6.1 Main Screen Descriptions

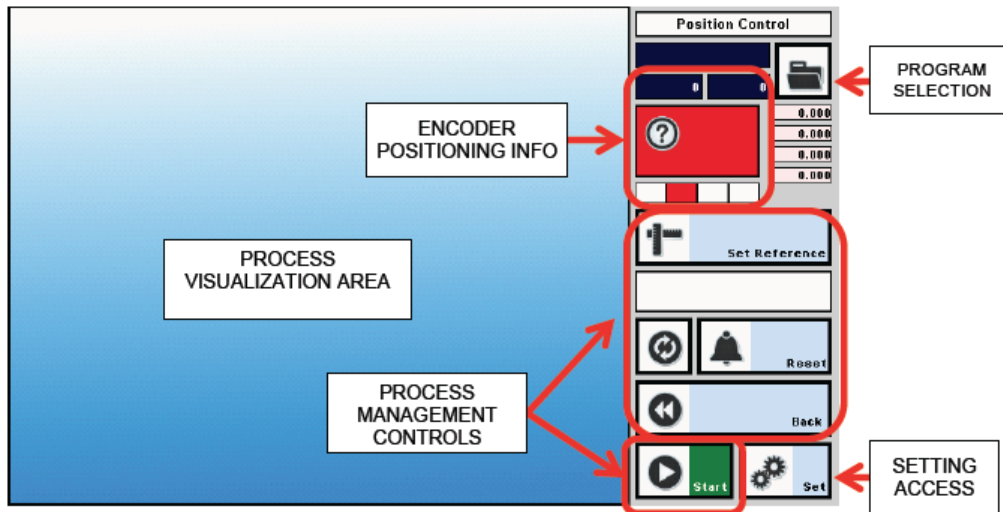

6.2 Access to Administrator Mode

To access the Admin mode, from the main screen tap "Set"

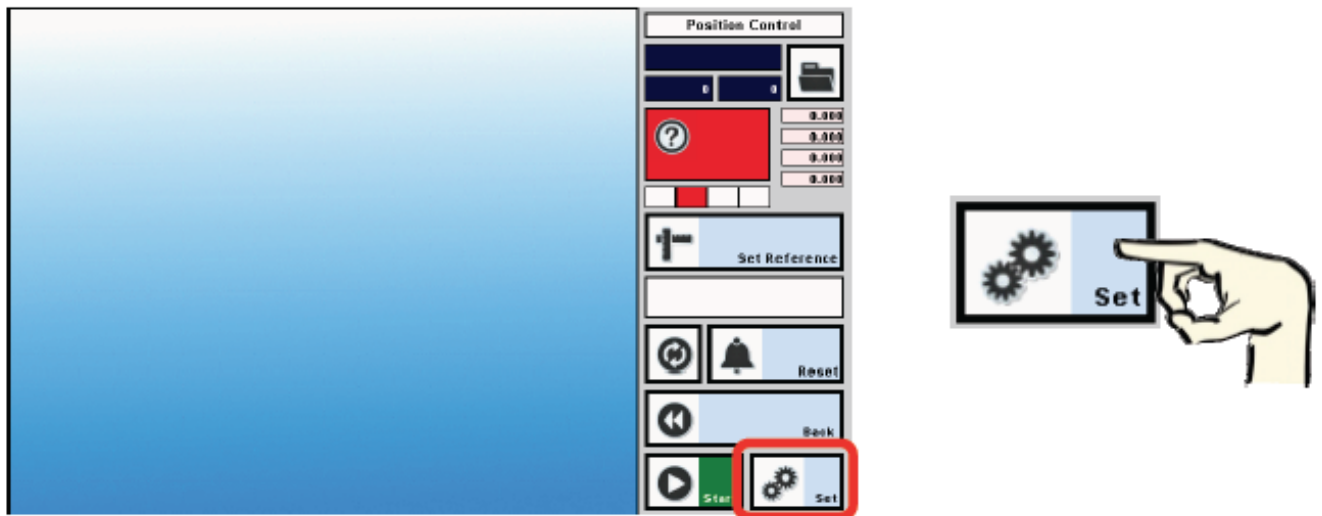

Enter into "Settings" screen

Section 6: Programming (Continued)

6.2 Access to Administrator Mode (Continued)

Description of Settings Screen

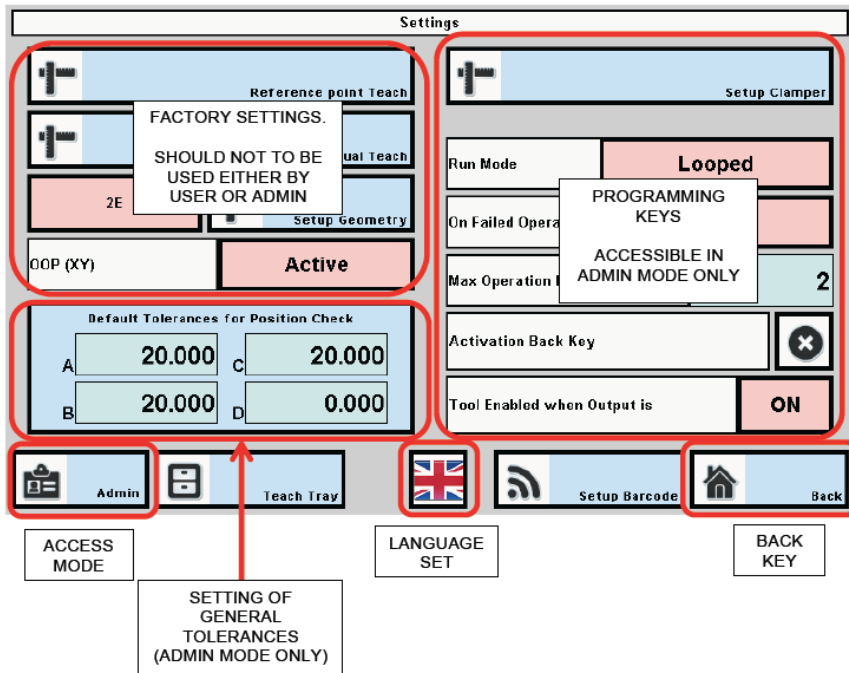

Tap "User"

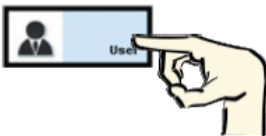

Section 6: Programming (Continued)

6.2 Access to Administrator Mode (Continued)

To enter into Admin mode, type the administrator password supplied by ASG through the popup keyboard, then tap "ENTER" (password shown below is not a valid password)

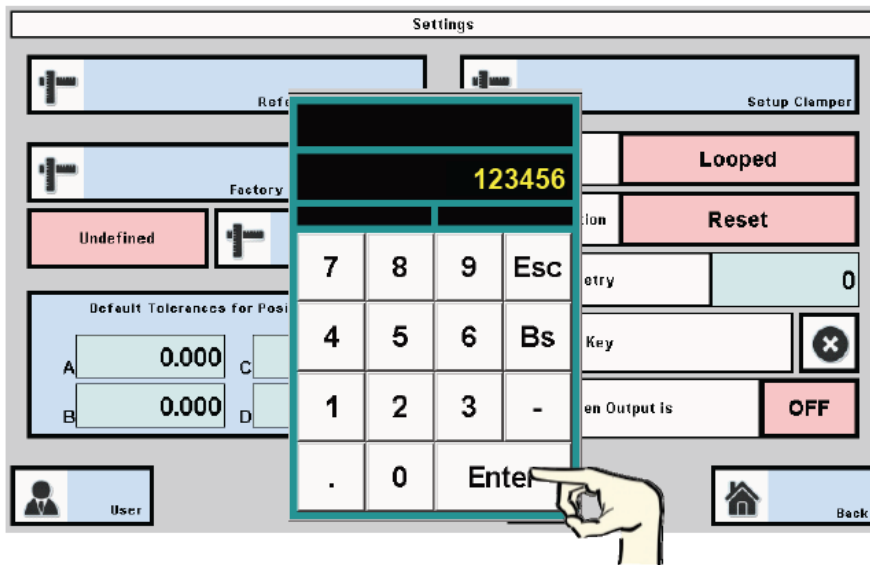

The screen is now into Admin mode and all functions are accessible.

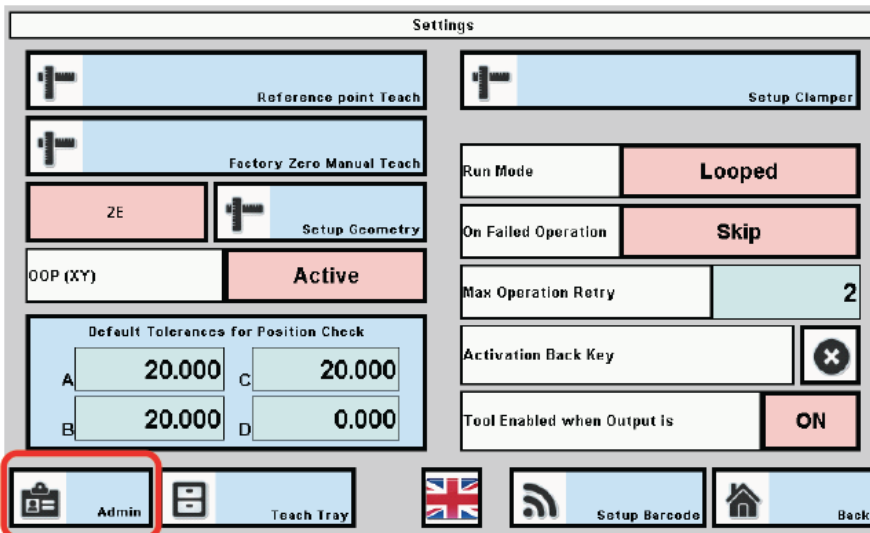

Section 6: Programming (Continued)

6.3 Exit Administrator Mode

To exit Admin mode, tap "Admin", then type "0" (zero) on the popup keyboard and "Enter". The "Settings" screen goes to "User" mode

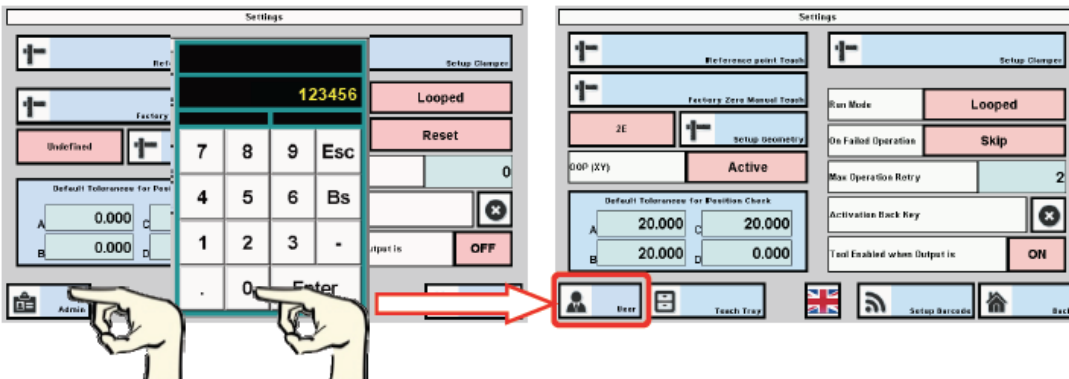

Tap "Back" and go to main screen "Position Control"

The ASG Nav-P 4.0 is now in User mode and is ready to start production process work.

6.4 Setting the Reference Start Position

The reference start position is the point to which the operator will leave the arm at the end of work day and where he will pick it up the next day, but after turning the ASG Nav-P 4.0 device power on. This point will serve as the zero position for all encoders when programming.

- It should be a resting point in which the torque arm can be clearly and firmly positioned
- It will have to be easily identified, so it should be supported by a mechanical rest point
- It could be either a tool holder or a specific arm rest position

Some examples in the following sketch:

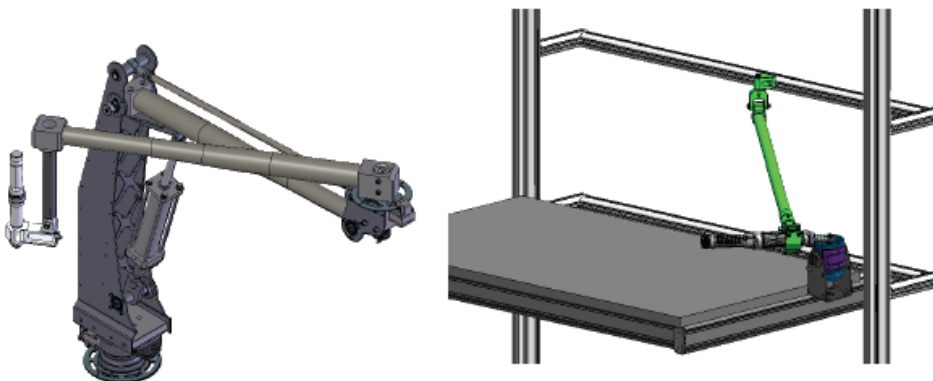

Section 6: Programming (Continued)

6.4 Setting the Reference Start Position (Continued)

6.4.1 Daily Confirmation or Restoration of Reference Point

1. Check that arm is in the pre-defined start reference position. If not, move it there.
2. Turn the ASG Nav-P 4.0 device on
3. Start working

In case the arm is not in the pre-defined reference startup position when the ASG Nav-P 4.0 is turned on:

1. Move the arm to the reference startup position
2. From main screen, tap "Set Reference".

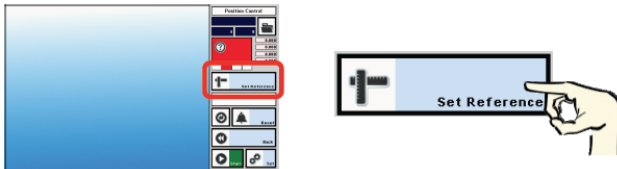

3. Start tightening process

6.5 Set-Up of Default Positioning Tolerances

This function allows setting of a general value of positioning tolerance which will be used as default for all cycles.



- It is also possible to set specific tolerance values for each selected tightening point. Procedure for setting specific tolerances is explained in paragraph 6.8.

1. From Service screen, tap Default Tolerance for Position Check

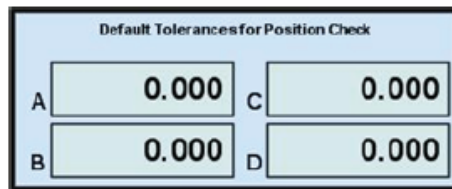
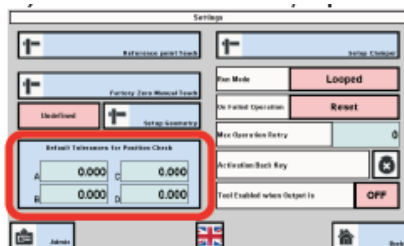

2. Tap windows A, B, C and D to set the tolerances and type the value using the pop-up keyboard

Section 6: Programming (Continued)

6.5 Set-Up of Default Positioning Tolerances (Continued)

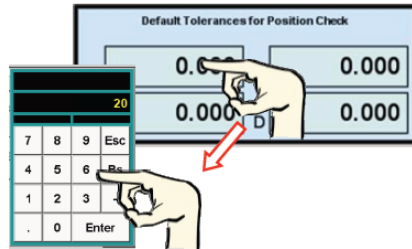

- A, B, C, D correspond to axis measured by arm encoders and are related to the arm geometry.

Type of Arm	A	B	C	D
1 Encoder Arm	X			
2 Encoder Arm	X	X		
3 Encoder Arm	X	X	X	
4 Encoder Arm	X	X	X	X

Table 2

3. After input completion, tap "Back" and go to Position Control main screen

6.6 Upload Part Pictures or Images to Device

To program the ASG Nav-P 4.0, a person with Admin rights should upload either pictures or CAD graphics of the part/ parts to be assembled into device. The pictures will help the user see the position of each tightening point and make the assembly sequence more efficient.

To upload the pictures into ASG Nav-P 4.0, follow this procedure:

1. Create a folder on a personal computer, named with the product name. Using concise names is suggested.
2. Take pictures of the components, save them in Bitmap 24bit format, resolution 600x480 pixels.
3. Name each picture with sequential numbers, starting from 001, 002, etc.
4. Save pictures into the folder with product name. If creating multiple folders, file names of the pictures in each folder must begin with 001.
5. Save the folder onto a USB flash drive
6. Insert the USB drive into the USB port on the device

Section 6: Programming (Continued)

6.6 Upload Part Pictures or Images to Device (Continued)

7. Tap "open file" on main screen and go to Work Management screen

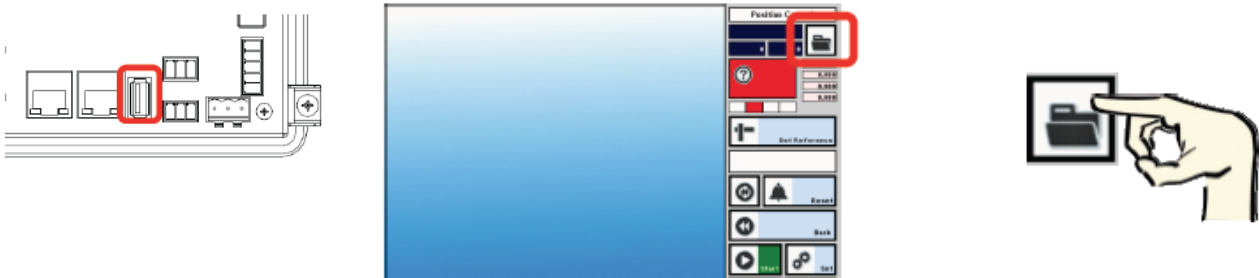

DESCRIPTION OF WORK MANAGEMENT SCREEN

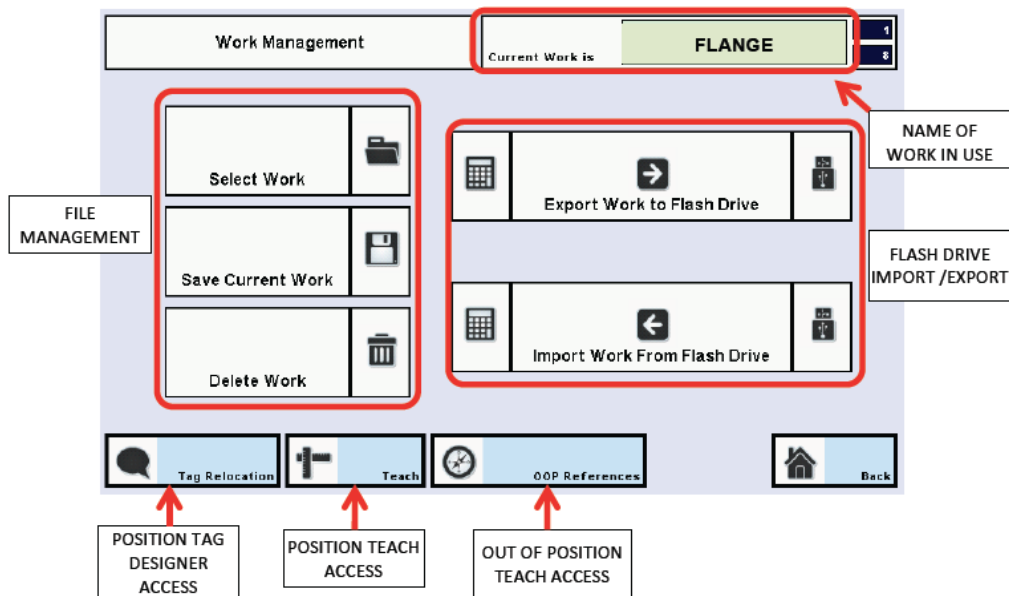

8. Tap "Import from flash drive"



Section 6: Programming (Continued)

6.6 Upload Part Pictures or Images to Device (Continued)

9. From pop-up window select the file name corresponding to the folder (e.g.: "Flange"), then tap "copy"

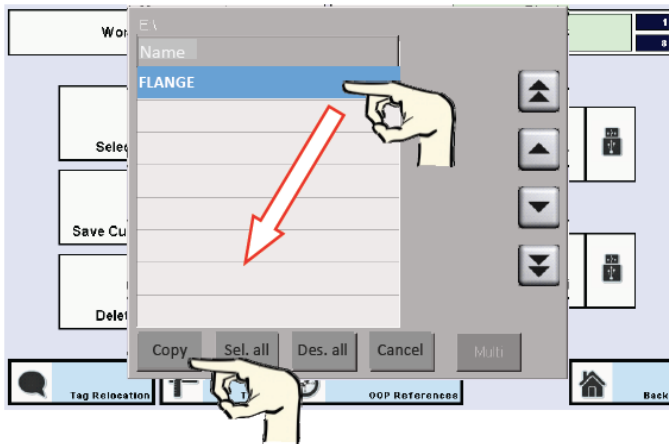

Wait until file is copied into ASG Nav-P 4.0 hard drive.

10. Tap Select Work

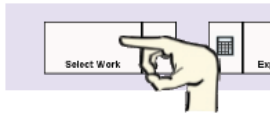

11. Select the desired work from the pop-up window, then tap "OK"

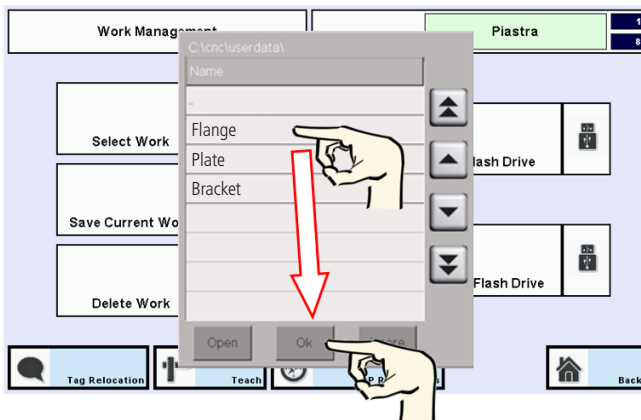

Section 6: Programming (Continued)

6.6 Upload Part Pictures or Images to Device (Continued)

The pictures are now uploaded. Here is an example of what will appear on screen:

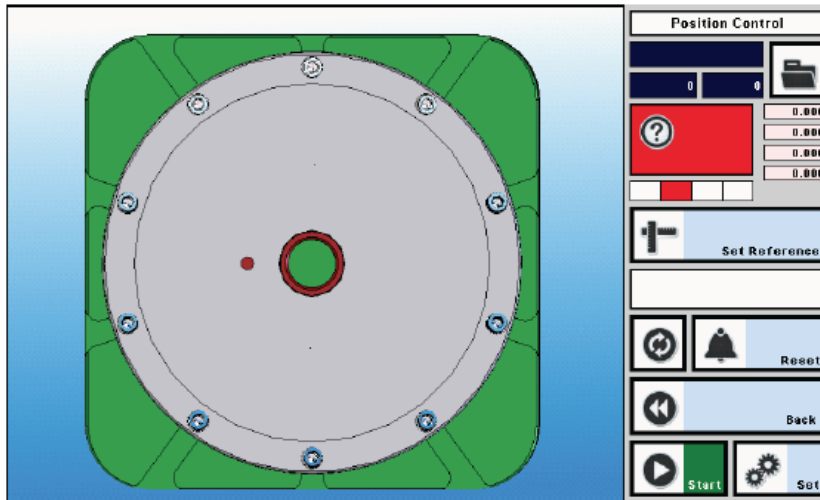

6.7 Positioning Tag Design

- Positioning tags are interactive icons which identify the tightening points of the process.
- Each tag will be numbered automatically during the design phase.
- Numbering of tags correspond to the assembly sequence, and it can also be linked to tightening program selected through the power tool control unit (controller).
- Tags change color and/or shape, according to the status mode:

ICONS IN TAG DESIGN MODE

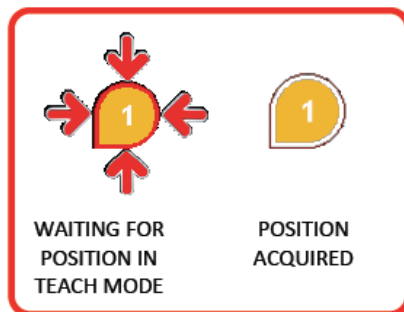

ICONS IN WORK MODE

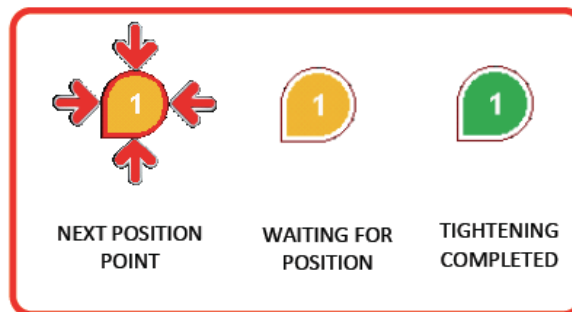

Section 6: Programming (Continued)

6.7 Positioning Tag Design (Continued)

6.7.1 Tag Design Sequence

1. Tap Tag Designer in the Work Management Screen



Enter into Operations and Layout screen, you will find the pre-loaded first tag ready to be moved to the first point of the sequence, like the example shown below.

DESCRIPTION OF OPERATIONS AND LAYOUT SCREEN

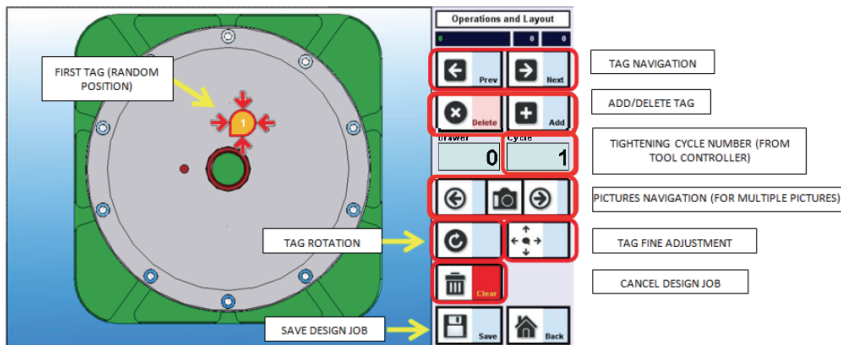

2. To move the tag to the first tightening point, tap on the first point position. The tag will move itself near to that position.

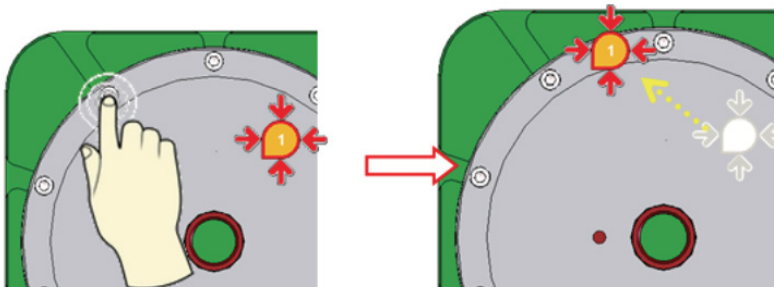

Section 6: Programming (Continued)

6.7 Positioning Tag Design (Continued)

6.7.1 Tag Design Sequence (Continued)

Tag position can be fine-tuned or rotated.

To fine-tune the tag position, tap on the icon and then tap on the arrows which appear on a NEW window. This way it is possible to precisely adjust the tag position over the picture.

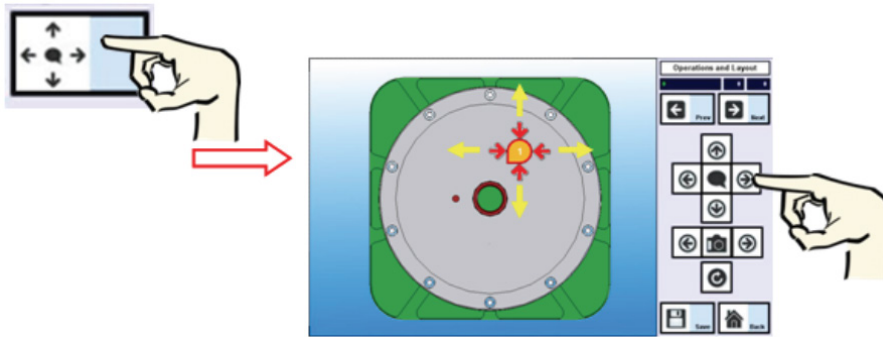

To rotate the tag, tap the icon and then tap until the tag reaches the desired rotation.

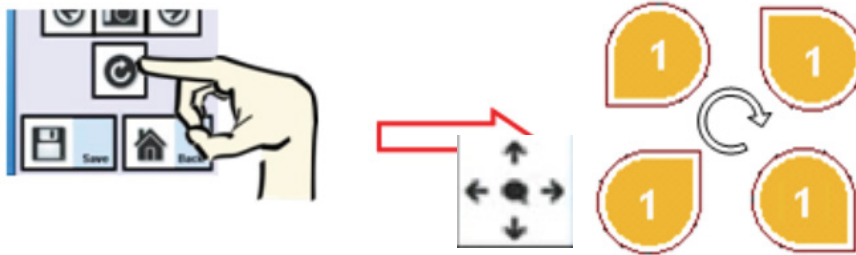

3. After these fine adjustments, tap "Back" and return to main screen d)
4. From main screen, select the tightening program by tapping Cycle, then digit the program number into pop-up keyboard and confirm with Enter

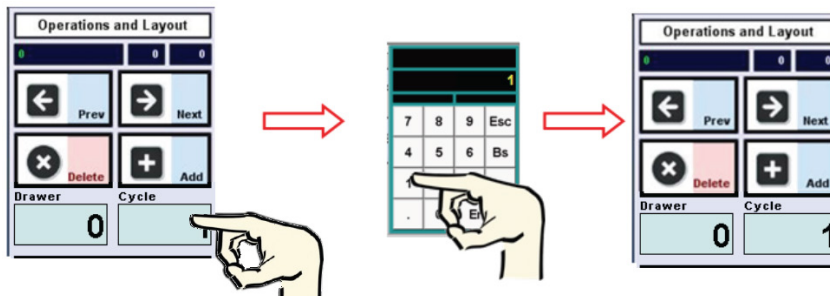

Section 6: Programming (Continued)

6.7 Positioning Tag Design (Continued)

6.7.1 Tag Design Sequence (Continued)

5. Add a new tag by tapping Add

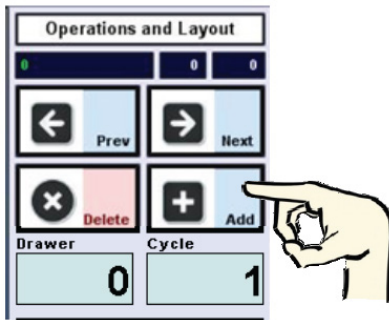

6. Repeat the sequence from 1) to 5) until the all tags have been added

- ! • Each tag is linked to a tightening program (cycle). Definition and programming of the tightening programs must be done separately by the end user with the power tool controller. ASG Nav-P 4.0 cannot manage, nor modify the tightening programs.

7. At the end of the sequence the screen should appear as follows

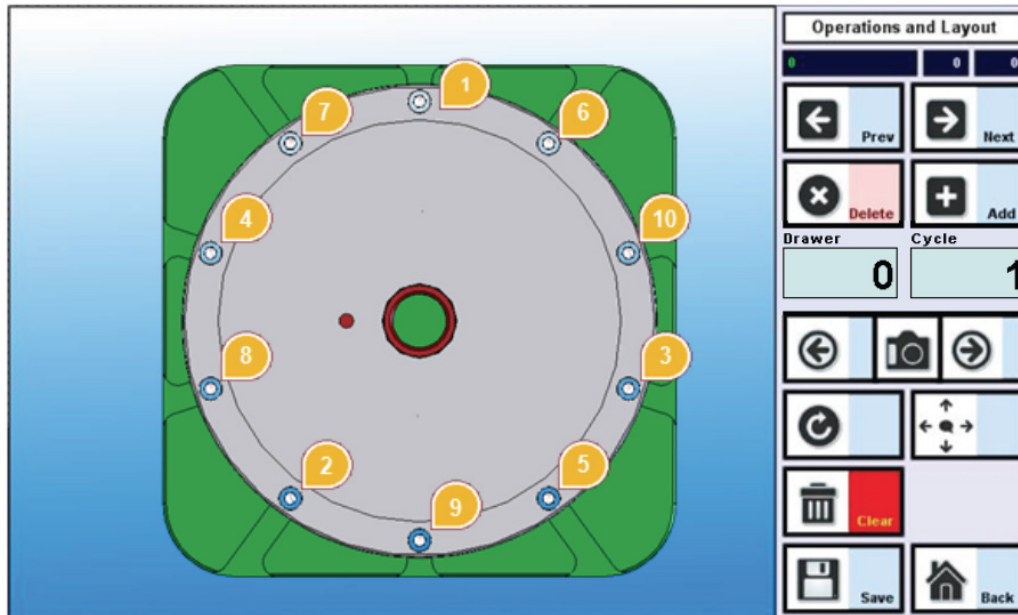

Section 6: Programming (Continued)

6.7 Positioning Tag Design (Continued)

6.7.2 Management of Multiple Pictures

In situations where the part image needs to be split in multiple images, ASG Nav-P 4.0 manages the change of those images in accordance with the tightening sequence.

To apply tags to multiple pictures, follow instructions in point 6.6, but when the first page is fully tagged, tap Add once more in order to create a new tag, then tap the right arrow on icon. The latest tag will be automatically transferred to the new page. You can then add more tags as described previously in 6.6

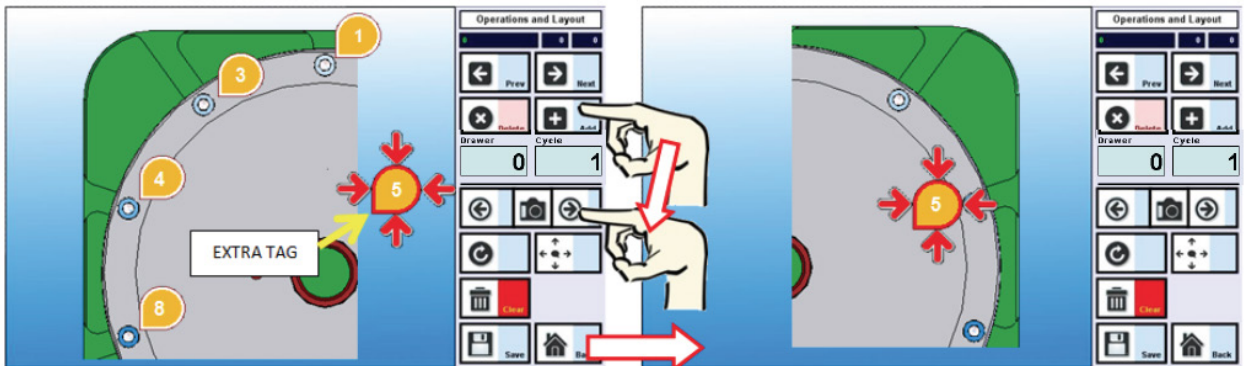

6.8 Teaching the Tightening Sequence Positions

After completion of tagging sequence, either with single or multiple pictures:

- Tap "Save"
- Tap "Back" and enter into Work Management screen and tap "Teach"

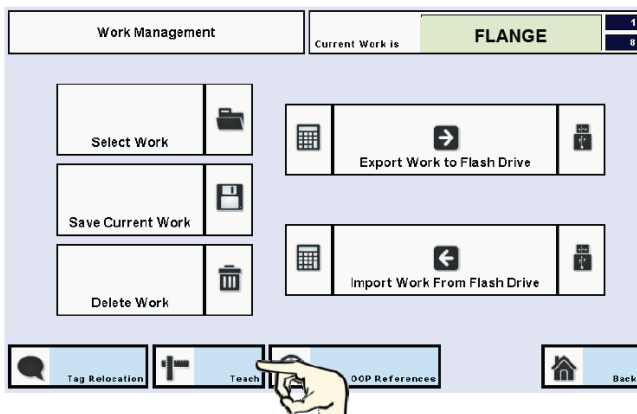

ASG, Division of Jergens, Inc.

Section 6: Programming (Continued)

6.8 Teaching the Tightening Sequence Positions (Continued)

Enter the Position Teach screen

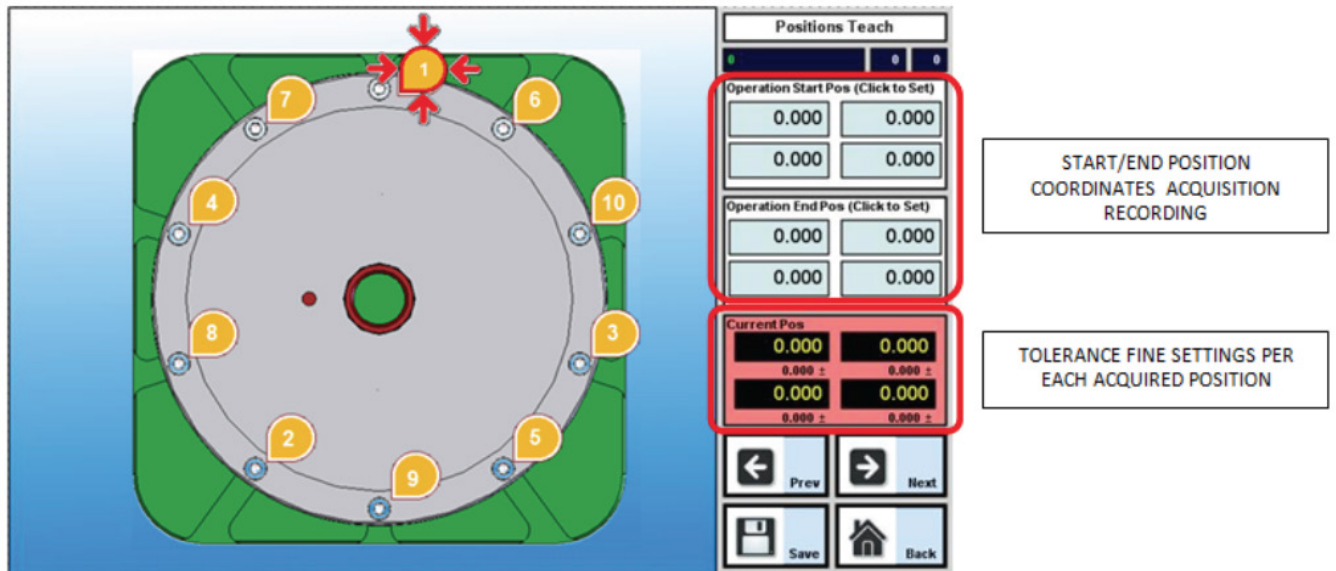

NOTE: the first tightening point tag goes to status change.

After graphical tagging, ASG Nav-P 4.0 must be taught the individual tightening positions. The person in charge of programming will need to maneuver the power tool installed on torque arm over the desired tightening points. Positions will have to be taught at each location. Below is the correct sequence for teaching the positions.

1. Position the power tool over the 1st tightening point

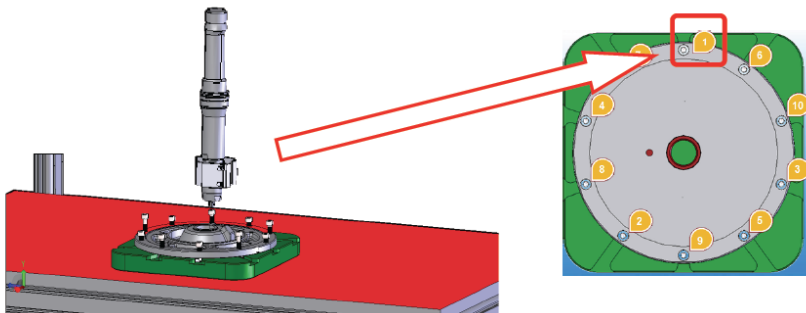

2. Tap over group of values named "Operation Start Pos"

Section 6: Programming (Continued)

6.8 Teaching the Tightening Sequence Positions (Continued)

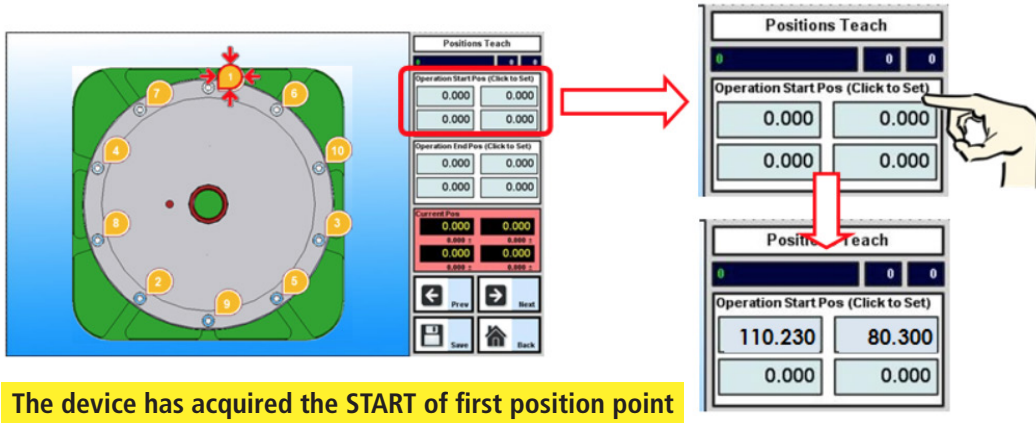

The device has acquired the START of first position point

3. Tighten the screw down to the end and tap over "Operation End Pos" field

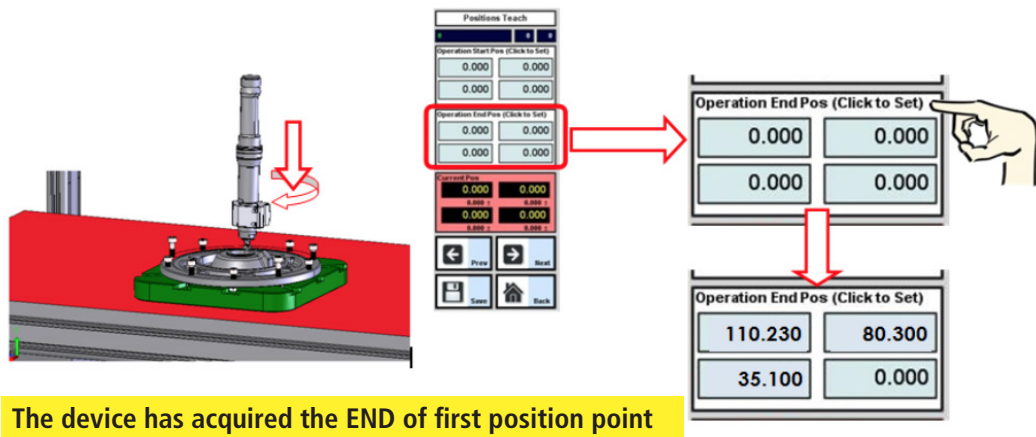

The device has acquired the END of first position point

4. Fine-tuning of position tolerance (optional)

To modify the position tolerance range with respect to Default Position Tolerance mentioned in Paragraph 6.5, tap on the "Current Pos" field and enter the tolerance value by using the pop-up keyboard, then tap Back to go back to Position Teach main screen. Be sure that the correct icon is highlighted for the position you intend to modify.

Section 6: Programming (Continued)

6.8 Teaching the Tightening Sequence Positions (Continued)

Follow the sequence shown here:

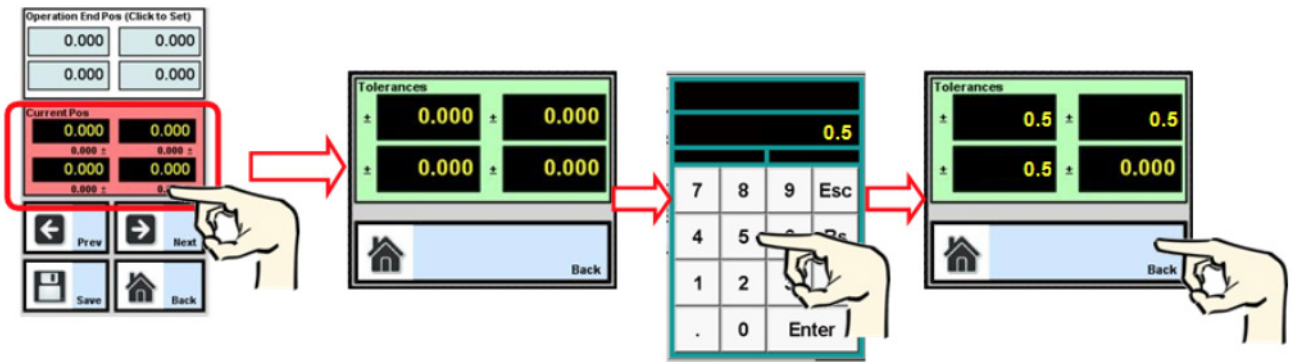

Once the configuration of first point is completed, the program moves automatically to next point.

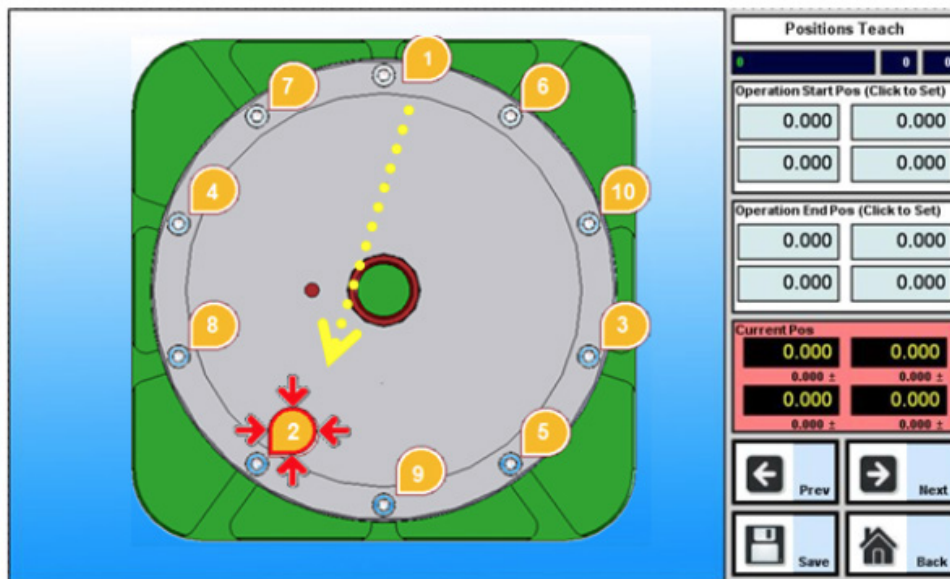

Repeat instructions 1- 4 above for the remaining tightening locations and tap the "Save" button.

Section 6: Programming (Continued)

6.8 Teaching the Tightening Sequence Positions (Continued)

6.8.1 Tag Modification

After the position teaching is completed, it is also possible to skip to previous or next tags for adjustments or modifications.

1. On Position Teach screen tap "Prev" or "Next" icons to move among tags
2. Modify the tag as needed.
3. At the end of tag design, tap "Save"
4. Tap "Back" to go to "Work Management" screen
5. Tap "Back" to go to "Settings" screen

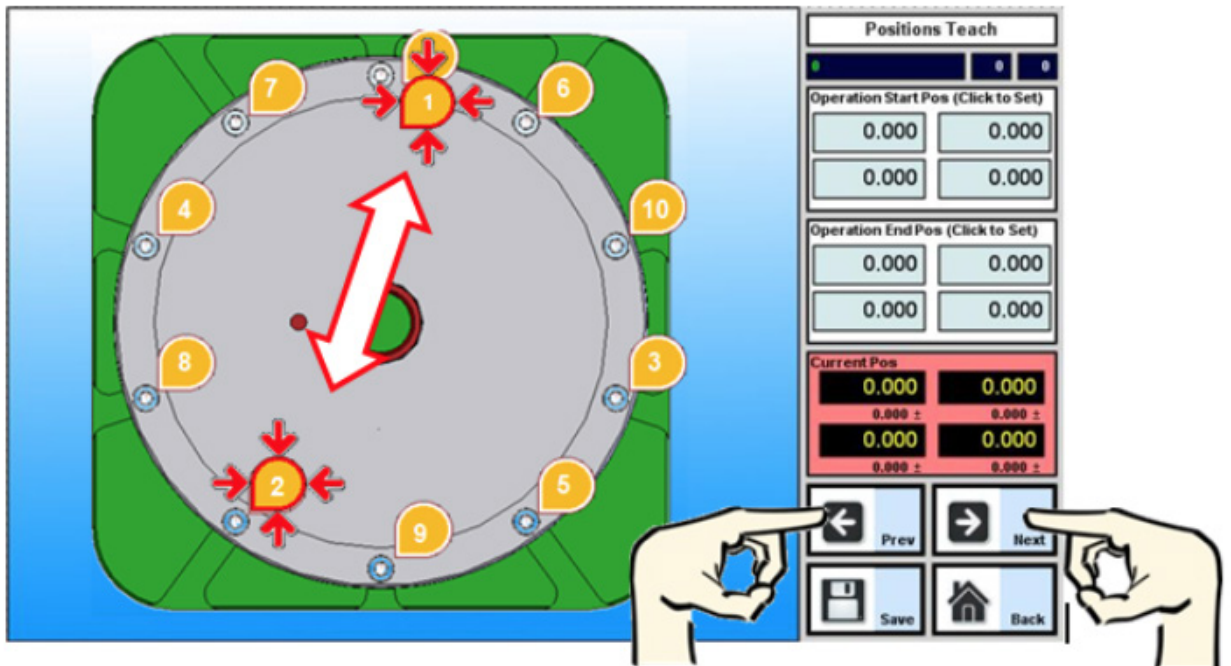

Section 7: Set-Up of Additional Functions

7.1 Clamper

This function allows activation of electro-valve for part locking at the beginning of the tightening process. There are different options:

- Present/absent: defines whether electro-valve is present or not
- Monostable/bistable: defines the type of electro-valve
- Use sensor/ Use time: defines clamping time in seconds. If "Use Sensor" is active there is an additional check for correct clamping activation. Sensor procurement is the end user's responsibility.

To select the above functions, tap "Setup Clamper" and then tap on the icons which appear on the popup window.

When finished with your settings, tap "OK" to complete the job.

Sample Pictures of Clamper Set-up Functions

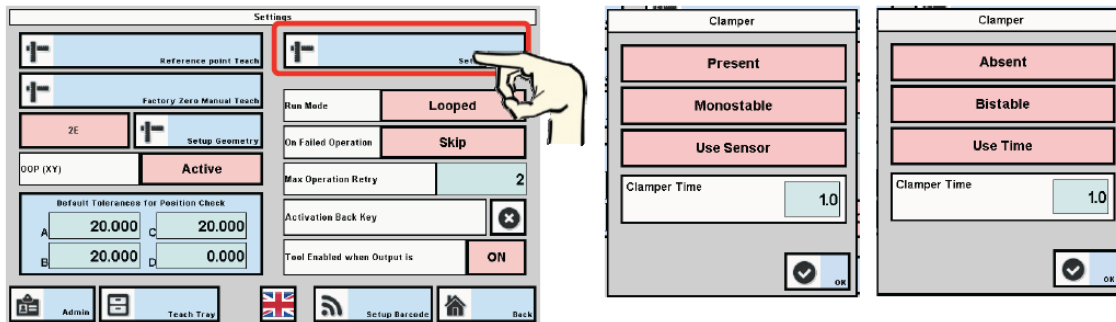

7.2 Run Mode

Options:

- Looped: automatically restart tightening cycle at the end of previous one.
- ! • This function cannot be activated when "Present" setting is active in "Setup Clamper"
- Start Each Piece: any new positioning cycle must to be activated by user by pressing the "Start" button or by an external input.

To select the desired option, tap on the pink field close to "Run Mode". The options will alternate as the button is tapped.

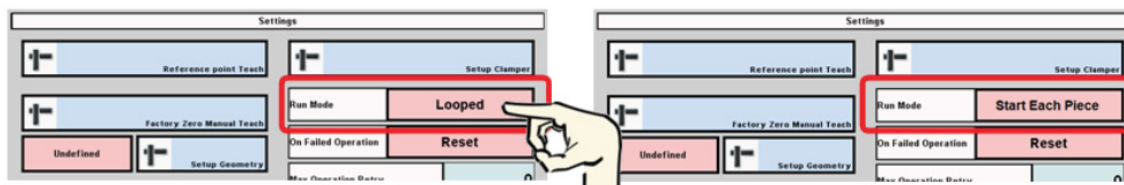

Section 7: Set-Up of Additional Functions

7.3 On Failed Operation

Define what the device should do when the maximum number of operation retries has been reached.

Options:

- Skip: goes to the next tightening point without scrapping the part
- Reset: user will have to manually reset the cycle, either scrapping the part or restarting from the beginning.

To select the desired option, tap on the pink field close to "On Failed Operation". The options will alternate as the button is tapped.

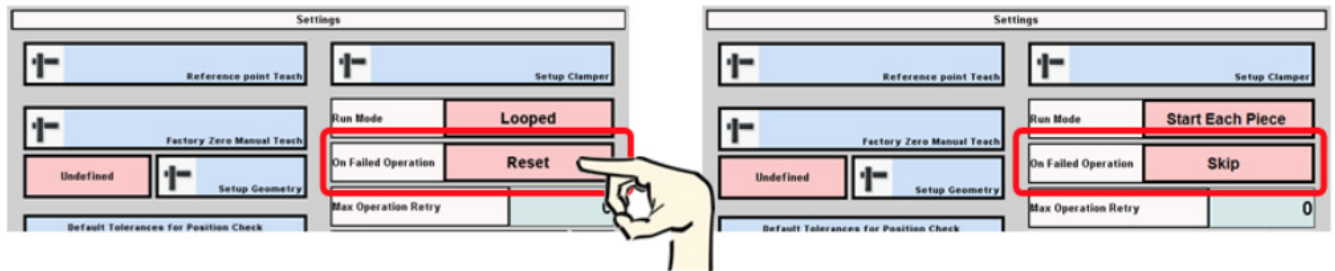

7.4 Max Operation Retry

Define the amount of maximum operation retries on a single position. Maximum value is 9.

To set the desired number of retries, tap on the light green field close to "Max Operation Retry" and digit the value on the popup keyboard, then tap "Enter"

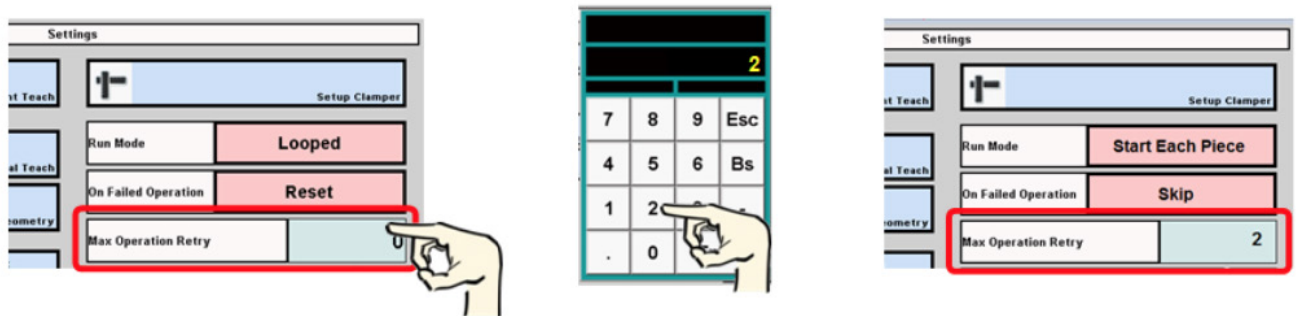

Section 7: Set-Up of Additional Functions

7.5 Activation Back Key

Activate/ deactivate the Back key, which allows users to go back to a previous tightening point. This may be done even if the previous tightening was OK.

To select the desired option, tap on the icon close to "Activation Back Key". The options will alternate as the button is tapped.

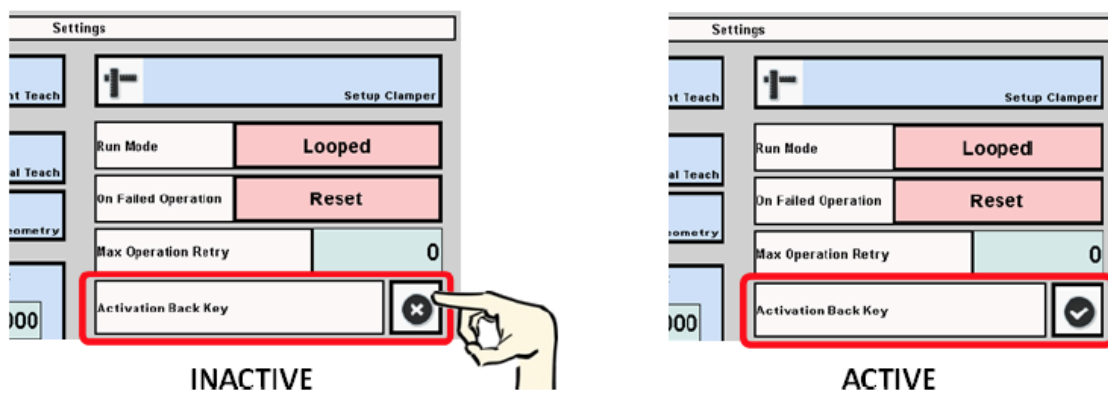

7.6 Tool Enabled When Output Is

This mode is related to the type of power tool in use, based upon its function logic.

To select the desired option, tap on the pink field close to "Tool Enabled When Output is".

The options will alternate as the button is tapped.

This function affects the behavior of Digital Output 5 – Power Tool Enabled

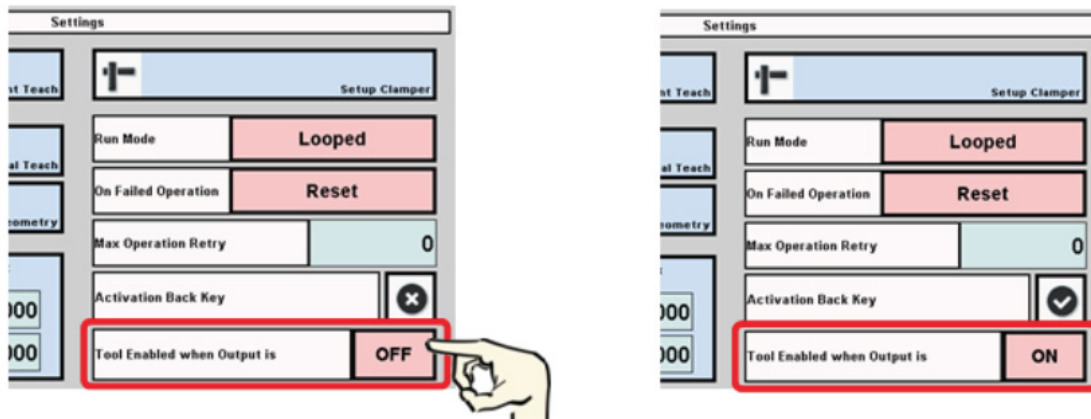

Section 7: Set-Up of Additional Functions

7.7 Barcode Reader Set-Up

This function allows using of a barcode reader with the device when the part is labeled with a barcode. It allows identification of the part and related tightening sequence.

Tap "Setup Barcode"

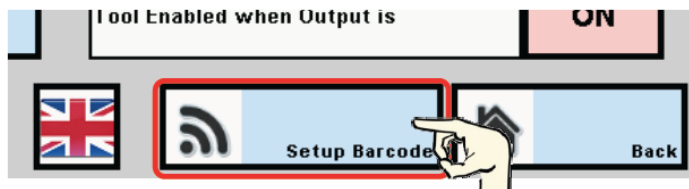

A popup window appears and will wait for input

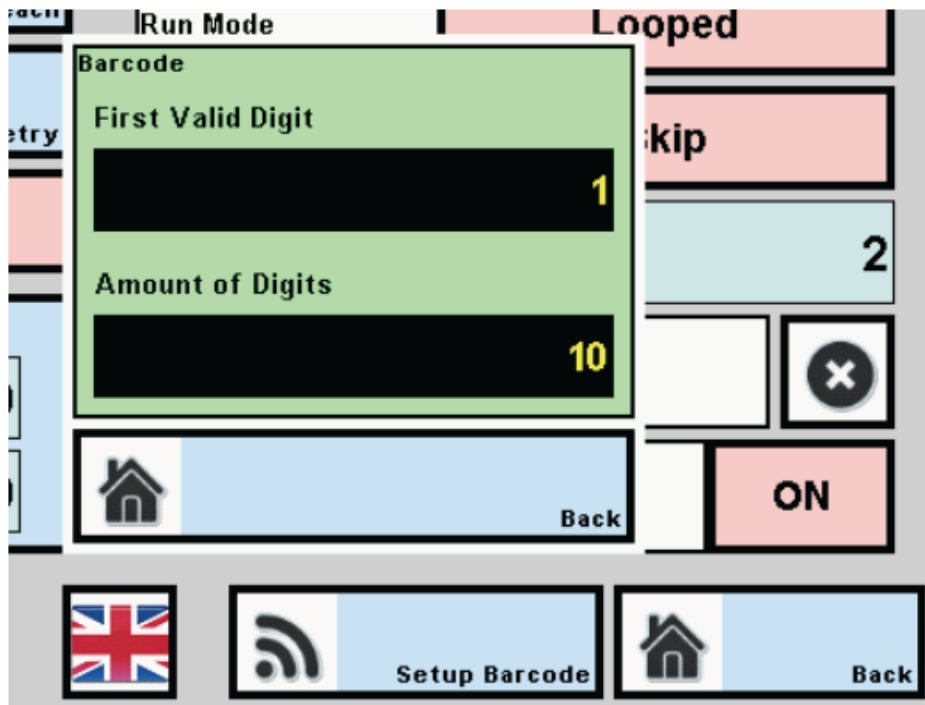

Section 7: Set-Up of Additional Functions

7.7 Barcode Reader Set-Up (Continued)

“First Valid Digit”: defines which is the first digit from which the software will read the barcode. Previous digits in the barcode will be disregarded. Default value is 1.

“Amount of Digits”: defines how many digits will be read by the software. Subsequent digits will be disregarded. Default value is 10

EXAMPLE

LABEL

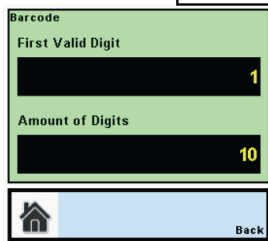
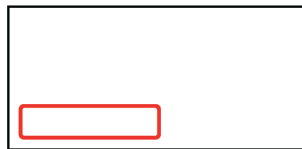

In the example shown here:

- First valid digit is 7
- Last valid digit is 0 (7th digit)

Other digits are disregarded

The valid barcode digits must match with the work folder name to select the proper tightening sequence.

The barcode reader has to be connected to the RS422/485 port (CN7) on the device

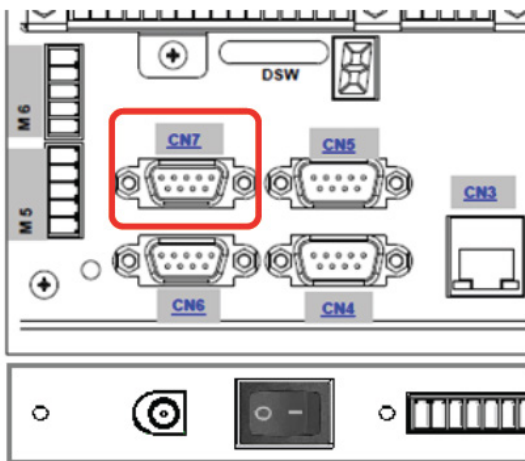

- The ASG Nav-P 4.0 was designed for a specific barcode reader, whose features are shown in Appendix 1. ASG guarantees the function only with this type of reader. Other reader models need to be tested. ASG denies any responsibility for missing functionality if a different reader is used.

Section 7: Set-Up of Additional Functions

7.8 Teach Tray

Allows the activation of the power tool at specific positions outside the tightening sequence. It is intended to allow the user to pick screws from a tray or a presenter.

After picking at the presenter, the power tool will not be active until it reaches the active tightening position of the programmed sequence.

1. Tap Teach Tray on Setting screen

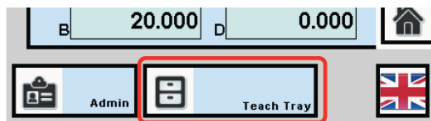

2. From Teach Tray Positions screen select the Tray Number by tapping on the arrows on the side

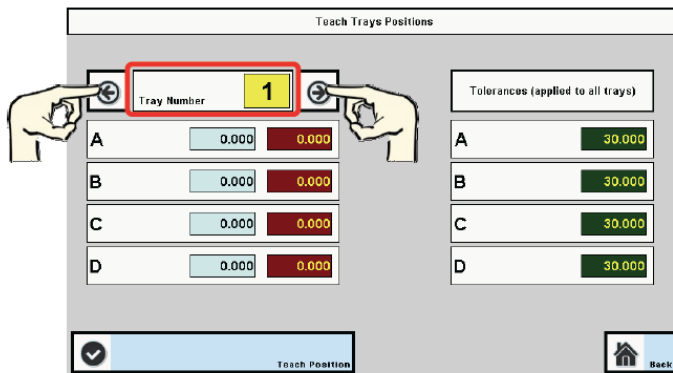

3. Move the power tool to the position corresponding to selected tray and tap "Teach Position"

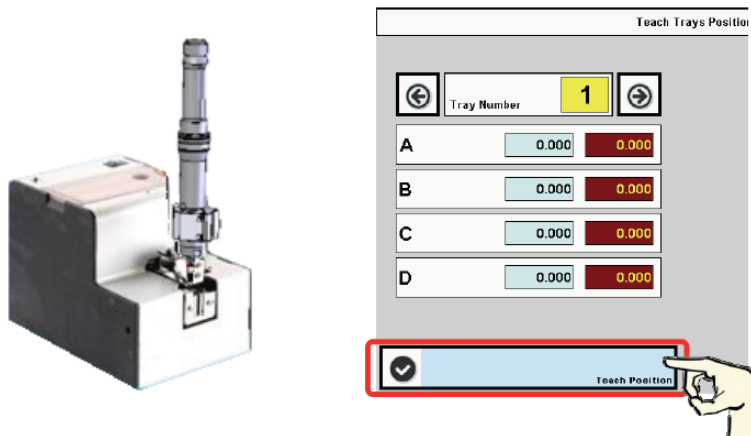

Section 7: Set-Up of Additional Functions

7.8 Teach Tray (Continued)

- If required, set the tray position tolerances using icons on the right side of the screen. Tap on the fields and type the tolerance value through the popup keyboard, then tap the "Enter" button.

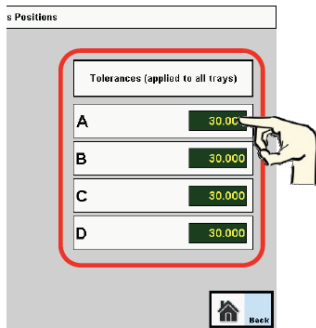

- Repeat the procedure for all other trays.

7.8.1 Tray Number Assignment to Work Cycle

A tray number can be also assigned to each work cycle during the tag design phase (see 6.7)

During Tag design phase in the Operation and Layout screen, tap on "Drawer" icon and then type the tray number corresponding to the tightening position.

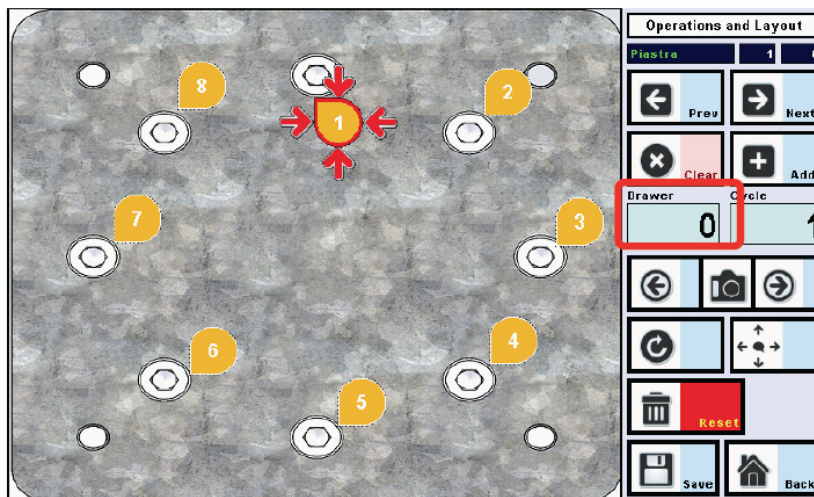

The tray number will be combined with the screw needed for that specific tightening position.

If the tray identification is unnecessary, leave 0 programmed in the "Drawer" field.

Section 7: Set-Up of Additional Functions

7.9 Out of Position (OOP) Reference

This function allows identification of a tightening sequence even if the part is not always in the same position during the assembly cycle. For example, when the part is not clamped on a jig and is placed on a table or a conveyor.

Positioning of the part must be on a plane surface. Should the part be positioned on a different height than the plane surface, the software will not detect it.

When OOP function is activated, the user can detect the part location by touching two reference Zero Points and then they can start the tightening.

When OOP function is activated, reference Zero Point detection must be repeated for each tightening sequence

1. In Setting screen, tap on right side of OOP (XY) icon, until "Active" appears in pink field.

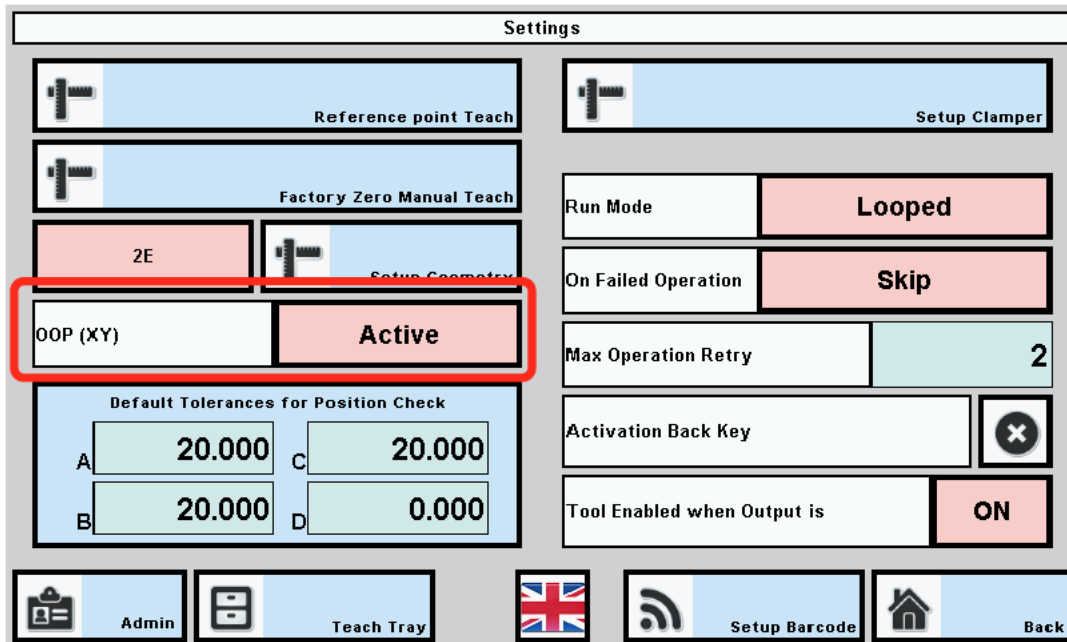

This is a global setting, therefore it will engage the OOP feature for all tightening sequences programmed into the system.

Section 7: Set-Up of Additional Functions

7.9 Out of Position (OOP) Reference (Continued)

2. Tap "Back" to enter the "Position Control" screen
3. Tap on "Open Folder" icon to enter the "Work Management" screen 
4. Tap on "OOP References" icon

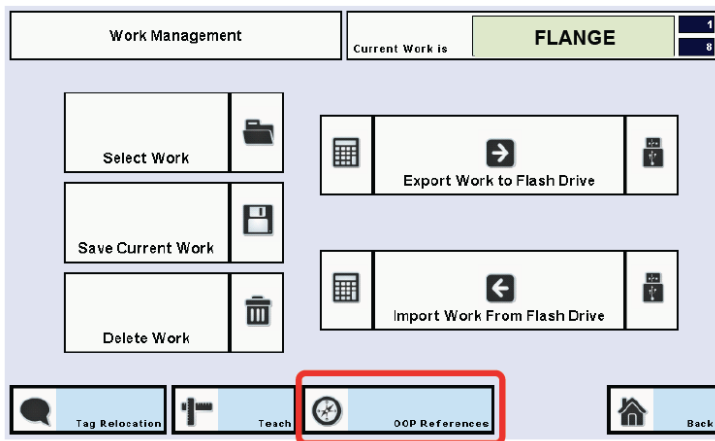

5. Enter the Teach Ref A & B screen

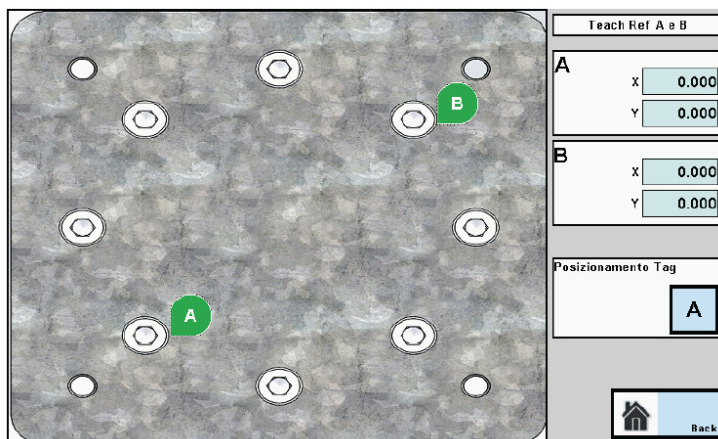

The first picture saved into the part folder (i.e. picture 001) is uploaded automatically

Tags for identification of Zero Points A and B can be positioned according to user needs by using the same procedure used in Tag design

Section 7: Set-Up of Additional Functions

7.9 Out of Position (OOP) Reference (Continued)

6. Position the tag A
7. Position the tool on the point corresponding to Zero Point A and tap on the "A -XY" icon over the "X-Y" fields

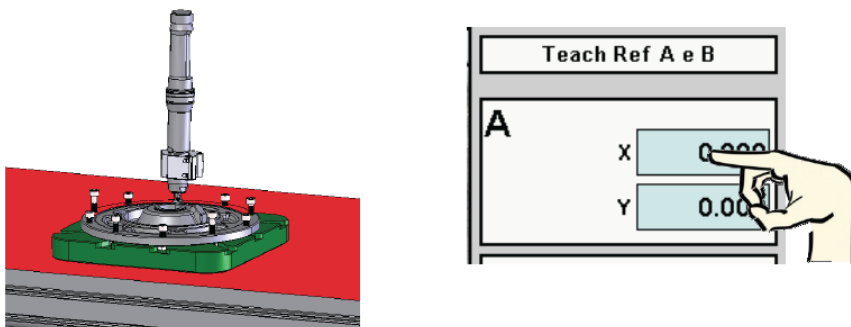

The device has acquired the Zero point A



- Zero Point positions are used only for the position identification. They might correspond to tightening positions, but the power tool will not be activated during the Zero Point detection phase.

To switch from tag A to tag B, tap on "Tag Positioning" icon

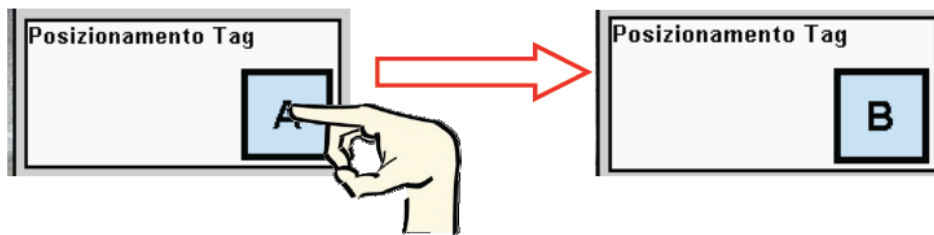

8. Repeat above procedure to acquire the Zero Point B position.
9. After the acquisition of Zero Point B, the software goes back to "Position Control" screen

From now on, the "Teach Ref A & B" screen will appear at the start of each work cycle with activation of the OOP function. The work process using the OOP function is explained in the paragraph 8.1.1

Section 8: Work Mode



8.1 Work Cycle

When ASG Nav-P 4.0 is in work mode, it can be controlled through Position Control screen by the user.

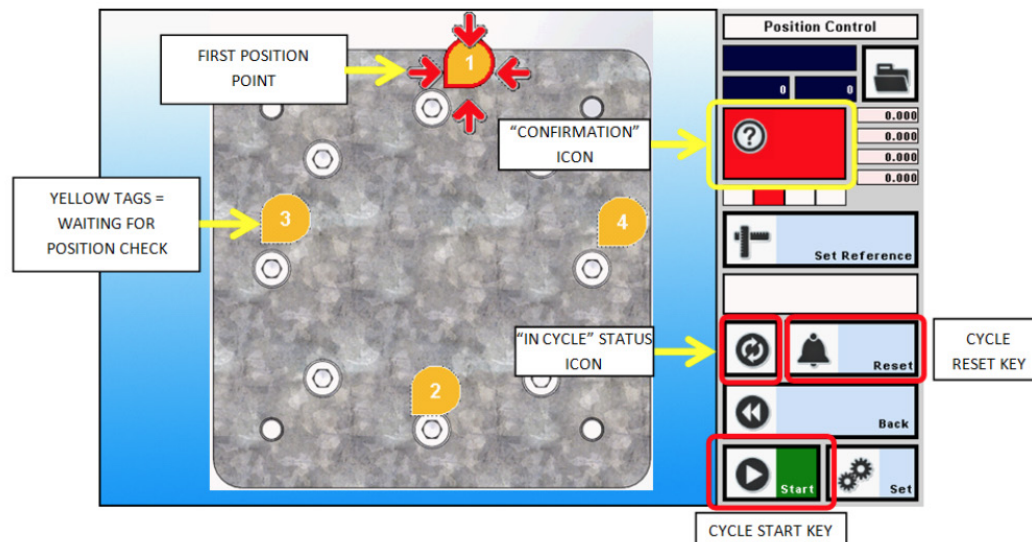
Description of "Position Control" Screen



How to start a new cycle:

1. Check that arm has been positioned into Start Reference Position. If not, place the arm in that position.
2. Turn ASG Nav-P 4.0 on and wait until the startup splash screen appears, tap the screen to advance to the Position Control screen.
3. Tap "Set Reference"
4.  Start Work cycle is now started. "In-cycle" icon turns into red:
5. Move the power tool over the first position point which is indicated with arrowed tag. Once the tool moves into the correct position, the "confirmation" icon turns into white and shows a check 

In this condition the power tool is allowed to start and to complete the tightening operation. If the tightening result is OK, the position tag color turns to green and the next tag becomes ready for the position check

Section 8: Work Mode (Continued)

8.1 Work Cycle

8.8.1 Work Cycle with OOP Function Active

1. Check that arm has been positioned into Start Reference Position. If not, place the arm in that position.
2. Turn ASG Nav-P 4.0 on and wait until the startup splash screen appears, tap the screen to advance to the Position Control screen.
3. Tap "Set Reference"
4. Tap "Start". In this case, the program goes to "Teach A&B" screen
5. Position the power tool on Zero Point A and tap on the "A -XY" icon over the "X-Y" fields
6. Position the power tool on Zero Point B and tap on the "B -XY" icon over the "X-Y" fields. After that the program goes to the first tightening point.
7. Start the tightening sequence.

8.2 Positioning Sequence Simulation

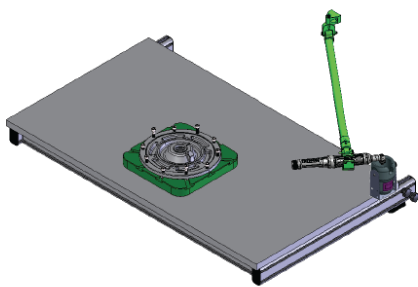

1) ARM IN REST POSITION

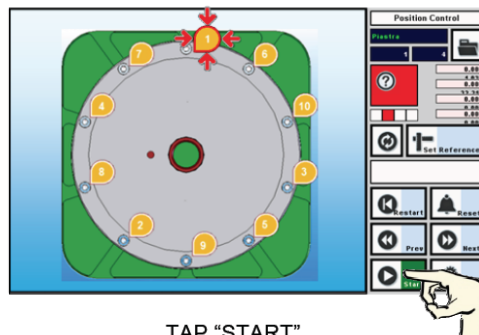

TAP "START"

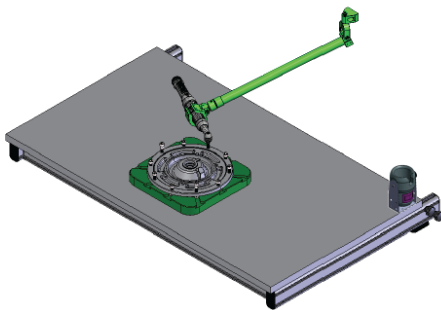

2) POSITIONING OVER FIRST POINT

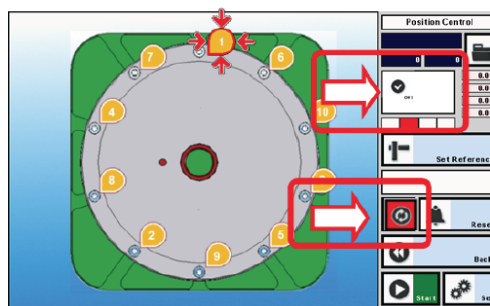

POSITION "OK" CONFIRMATION

Section 8: Work Mode (Continued)

8.2 Positioning Sequence Simulation (Continued)

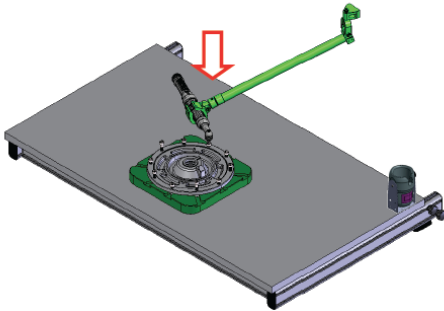

3) TIGHTENING COMPLETE



FIRST SCREW COMPLETED (TIGHTENING OK)

The device is now ready for the next tightening point. To complete the sequence, repeat steps from 1)

8.3 Job Selection From External Source

The ASG Nav-P 4.0 device allows program selection from external source.

In this mode, the programs can be selected through digital input in binary mode.

To use the external program selection:

- Connect through the M7 connector to the Job Selection inputs (Inputs 10-15) as indicated in the Input Output lists in 3.4
- When loading images via USB, name the program folders with a numeric value (starting from 001) corresponding to Job which will be recalled through the digital input



Section 9: Maintenance

The ASG Nav-P 4.0 device is maintenance free.

Section 10: Disposal

Dispose components and parts in compliance with all local laws and safety procedures.

Section 11: Limited Warranty

1. This product is guaranteed against defective workmanship or materials, for a maximum period of 12 (twelve) months following the date of purchase from ASG, Division of Jergens Inc. or its agents, provided that its usage is conforms to directions described in this manual.
2. During the validity of warranty period, should the product show any material or functional defect, it must be returned to ASG or its agents, together with a short description of the alleged defect. ASG shall, at its sole discretion, arrange to repair or replace free of charge such items as are deemed faulty by reason of defective workmanship or materials.
3. This warranty ceases to apply to products which have been abused, misused or modified, or which have been repaired using other than genuine or authorized ASG spare parts or by someone other than ASG or its authorized service agents.
4. Should ASG incur any expense correcting a defect resulting from abuse, misuse, accidental damage or unauthorized modification, they will require that such expense shall be reimbursed in full.
5. ASG will not accept claims either for labor or other expenditure made upon defective products.
6. Any direct, incidental or consequential damages whatsoever arising from any defect are expressly excluded.
7. This warranty is given in lieu of all other warranties, or conditions, expressed or implied, as to the quality, merchantability or fitness for any particular purpose.
8. No one, whether an agent or employee of ASG, is authorized to add to or modify the terms of this limited warranty in any way



ASG Nav-P 4.0 System User Manual

Section 12: Appendixes

12.1 ASG Nav-P 4.0 Power Unit

Input	
AC Input Voltage Rating	00 to 240V AC
AC Input Voltage Range	90 to 264V AC
AC Input Frequency	47 to 63Hz
Input Current	1.5A (RMS) maximum at 120V AC
Leakage Current	0.25mA maximum
Inrush Current	<60A for 100V AC at maximum load <100A for 240V AC at maximum load (Cold start at ambient 25°C)
Input Power Saving	0.3W maximum at no load
Rise Time	100mS maximum at full load, 120V AC

Output	
Efficiency	87-92%; meets requirements for Level V efficiency marking

Environmental		
Temperature:	Operation 32 to 104°F (0 to +40°C) Non-operation -13 to 158°F (-25 to +70°C) Humidity 0 to 90%	
Emissions:	FCC Class B EN55022 Class B	
Immunity:	IEC61000-4-2 Level 4,	IEC61000-4-3
	IEC61000-4-4	IEC61000-4-5
	IEC61000-4-6	IEC61000-4-8
	IEC61000-4-11	EN61000-3-2
Over-Voltage/Over-Current Protection:	Auto restart without damage	
Short-Circuit Protection:	Output can be shorted without damage	
Dielectric Withstand (Hi-pot) Test:	Input to Output: 3000V AC for 1 min., 10mA	
Insulation Resistance:	Input to output: 7M ohm, 500V DC	
DC Output Connector (Barrel Type):	2.1 x 5.5 x 9.5mm Center Positive Standard	
DC Cord Length:	1.5m	
AC Input Clips: RPA:	US RPI: India RPB: Brazil RPK: UK RPC: China RPN: Argentina - RPE: Europe RPS: Australia RPH: Korea RPX: IEC320 C8	

Section 12: Appendixes (Continued)

12.1 ASG Nav-P 4.0 Power Unit (Continued)

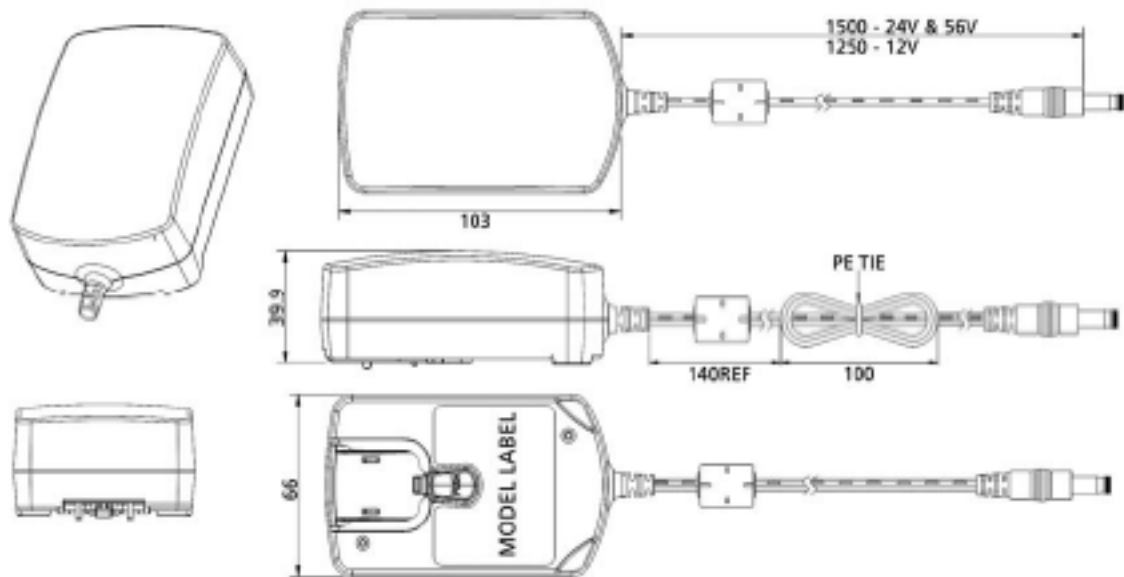



Section 12: Appendixes (Continued)

12.2 Bar Code Reader

Brand: DATALOGIC

Model: Touch TD1100 90 LITE RS232

Technical features:

DECODING CAPABILITY

1D / LINEAR CODES Autodiscriminates all standard 1D codes including GS1 DataBar™ linear codes.
STACKED CODES GS1 DataBar Expanded Stacked; GS1 DataBar Stacked; GS1 DataBar Stacked
Omnidirectional

ELECTRICAL

CURRENT Operating (Typical): < 100 mA @ 5 VDC

Standby/Idle (Typical): 20 mA @ 5 VDC INPUT VOLTAGE 5 VDC +/- 0.5 V

ENVIRONMENTAL

AMBIENT LIGHT 0 - 20,000 lux

DROP RESISTANCE Withstands repeated drops from 1.5 m / 5.0 ft onto a concrete surface

ESD PROTECTION (AIR DISCHARGE) 16 kV

HUMIDITY (NON-CONDENSING) 5 - 95%

PARTICULATE AND WATER SEALING IP30

TEMPERATURE Operating: 0 to 50 °C / 32 to 122 °F - Storage/Transport: -20 to 70 °C / -4 to 158

INTERFACES

INTERFACE RS-232

PHYSICAL CHARACTERISTICS

DIMENSIONS: 17.0 x 10.4 x 6.7 cm / 6.7 x 4.1 x 2.7 in

WEIGHT 90 Pro & Lite: 153.0 g / 5.4 oz

READING PERFORMANCE

LIGHT SOURCE Illumination: 640 nm LED

PRINT CONTRAST RATIO (MINIMUM) 25%

READ ANGLE Pitch: +/- 65°; Roll (Tilt): +/- 45°; Skew (Yaw): +/- 70°

READING INDICATORS Beeper (Adjustable Tone); Good Read LED

RESOLUTION (MAXIMUM) 0.102 mm / 4 mil

READING RANGES

TYPICAL DEPTH OF FIELD Minimum distance determined by symbol length and scan angle.

Printing resolution, contrast, and ambient light dependent.

Code 39: 7.5 mils: 0 to 8.1 cm / 0 to 3.2 in

Code 39: 10 mils: 0 to 12.0 cm / 0 to 4.7 in

EAN13: 13 mils: 0 to 15.0 cm / 0 to 6.0 in

ASG, Division of Jergens, Inc.

Section 12: Appendixes (Continued)

12.2 Bar Code Reader (Continued)

REGULATORY

LED Emission Class (IEC-62471:2006-07) Exempt Risk Group (RG 0)

Electrical Safety IEC 60950-1 , CAN/CSA C22.2 No. 60950-1-07; UL 60950-1

EMI/RFI North America (FCC) : Part 15 Class B, Canada (IC) : ICES-003 Class B, European Union EMC

Directive, Australian (C-tick), Russia (Gost); Korean KCC; Japan (VCCI)

Additional components accessories needed for using the reader:

CAB-327 Serial cable

PG5-05P55 Power unit 5VDC

Power cord

CN7 Bar Code Port Information

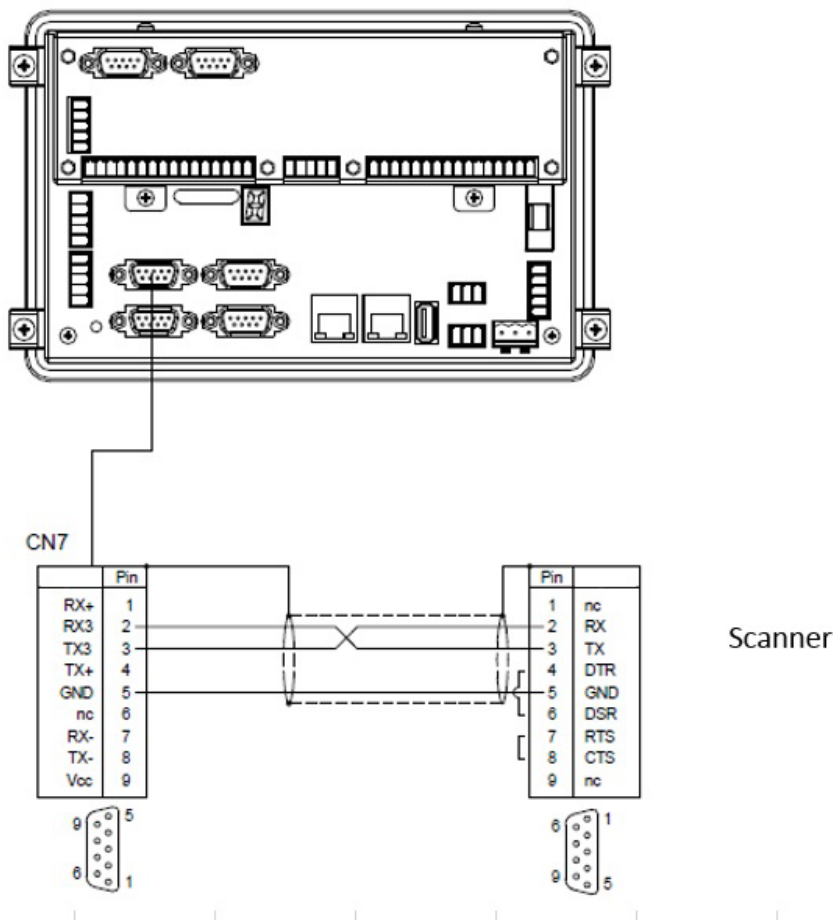

ASG, Division of Jergens, Inc.

Section 12: Appendixes (Continued)

12.3 Digital Inputs

M7 – M8

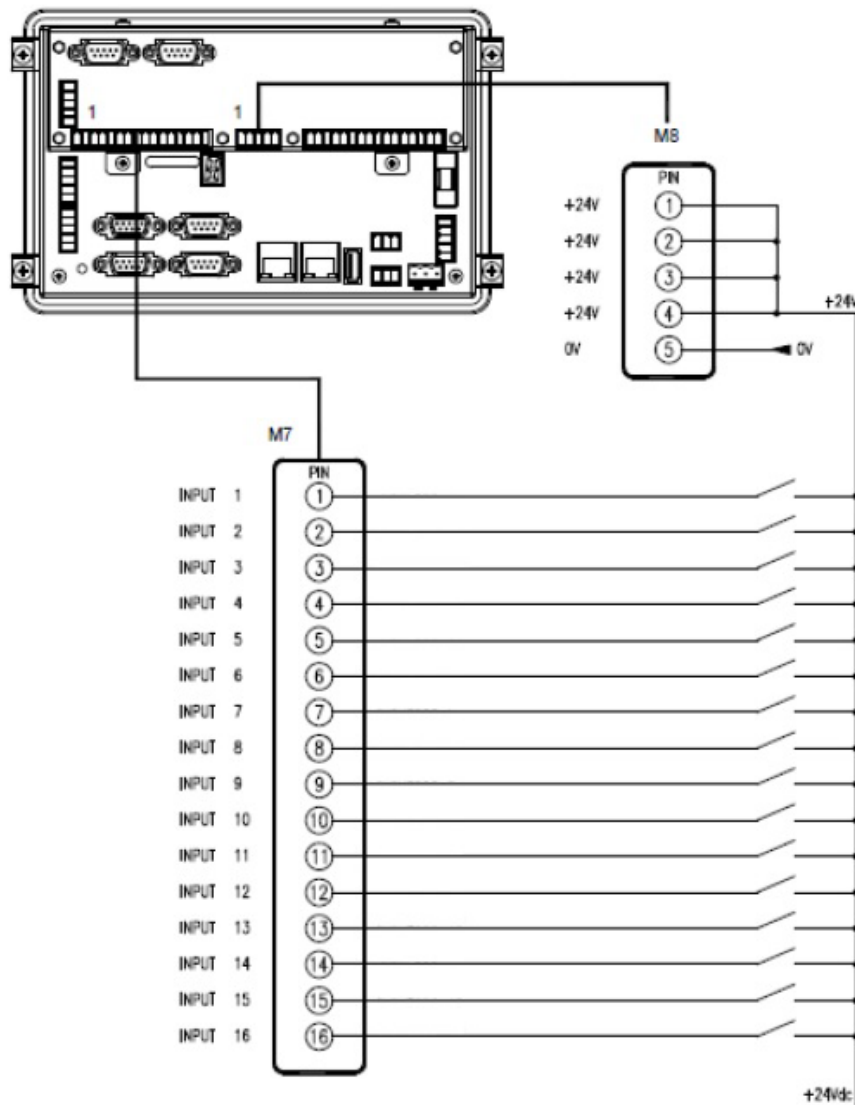

Inputs are Opto-Isolated
 Nominal Voltage: 24Vdc (+15 - +30Vdc)
 Input Current: 10mA (at 24Vdc)
 Input common internally connected to 0Vdc – cannot be switched.

ASG, Division of Jergens, Inc.

Section 12: Appendixes (Continued)

12.4 Digital Outputs

M8-M9

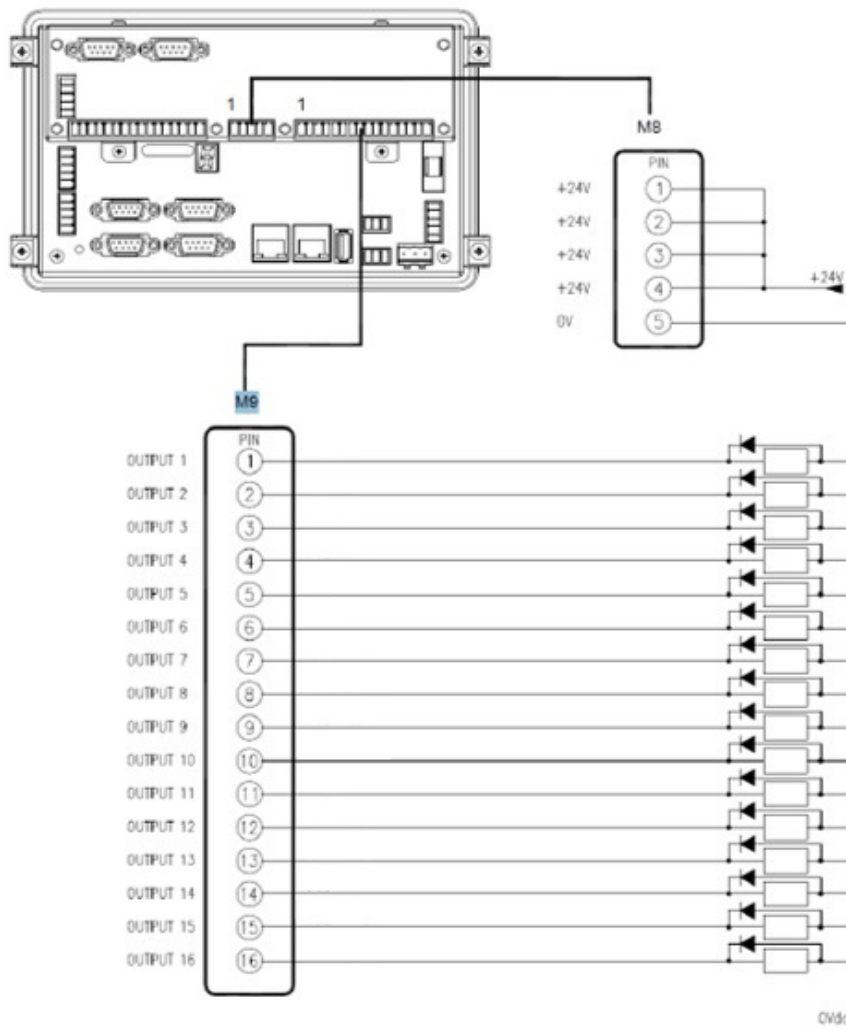

16 static outputs
short circuit protected
 OUTPUT VOLTAGE : PNP - 24Vdc
 OUTPUT CURRENT : 2A per single output
 1.5A with all output ON